

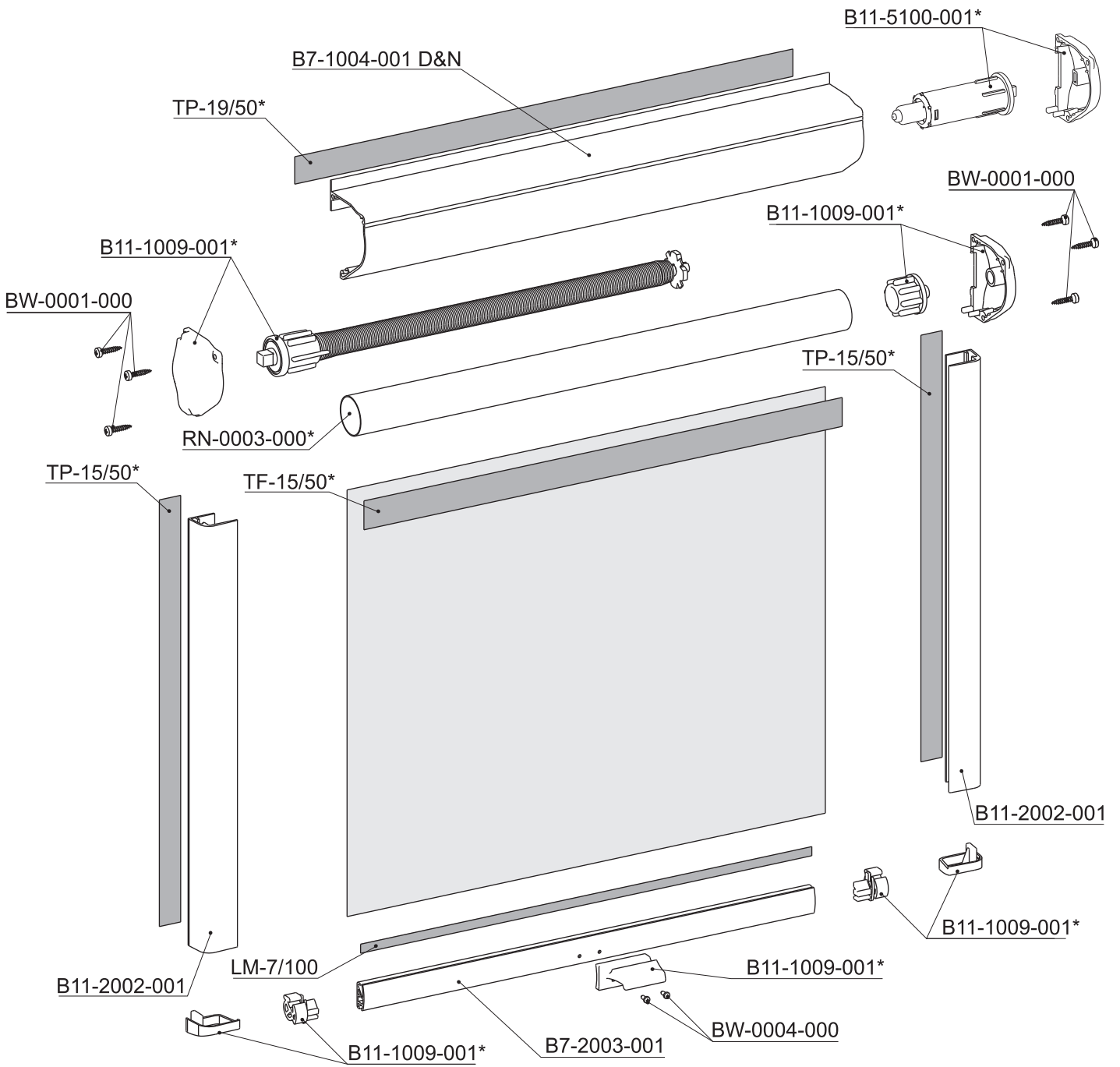







BAMAR-11

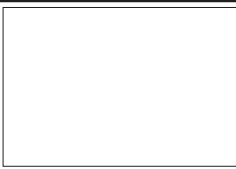





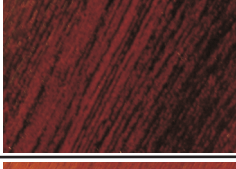

ALU

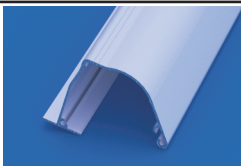
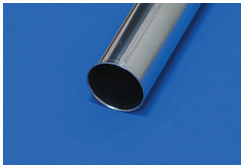
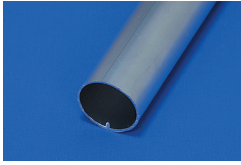

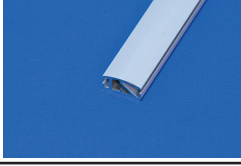

*	↻
RN-0003-000	RN-0007-000
B11-1009-001	B11-1109-001
B11-5100-001	B11-5200-001
TF-15/50	DW-19/50, NTF-15/50, NDW-19/50
TP-15/50	NTP-15/40

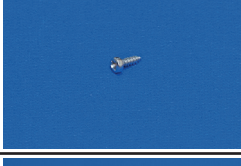
BAMAR 11:

Kod Code Code Код	Kolor	Colour	Farbe	Цвет	
001	biały	white	weiss	белый	
002	brązowy	brown	braun	коричневый	
111	srebrny	silver	silber	серебристый	
308	dąb złoty	gold oak	eiche-gold	золотой дуб	
309	jasny dąb	light oak	eiche-hell	светлый дуб	
310	orzech	nut brown	nuss	орех	
311	mahoń	mahogany	mahagoni	махагон	
312	wisnia	cherry red	kirsche	ВИШНЯ	
313	orzech wenge	wenge nut	nuss-wenge	венге	

Kod Code Code Код	Nazwa Name Bezeichnung Название	Kolor Colour Farbe Цвет	Pakowanie Packing Packen Упаковка	
B7-1004-001 D&N	Kaseta aluminiowa B7 biała, 6m	001, 002, 111, 308,	48 mb	
	Aluminium cassette B7 white, 6m	309, 310, 311, 312,	48 lm	
	Aluminiumkassette B7 weiss, 6 lm	313	48 lm	
	Кассета алюминиевая B7 белая, 6м		48м	
RN-0003-000	Rura aluminiowa, 25,0 x 0,7, 6m	000	60 mb	
	Aluminium tube 25,0x0,7, 6m		60 lm	
	Aluminiumrohr 25,0 x 0,7, 6m		60 lm	
	Труба алюминиевая 25,0 x 0,7 6м		60 м	
RN-0007-000	Rura aluminiowa 26,3 x 1,15, 6m	000	60 mb	
	Aluminium tube 26,3x1,15, 6m		60 lm	
	Aluminiumrohr 26,3 x 1,15, 6m		60 lm	
	Труба алюминиевая 26,3 x 1,15, 6м		60 м	
B11-2002-001	Prowadnica zaokrąglona B11 biała, 6m	001, 002, 111, 308,	120 mb	
	Aluminium side guide round B11 white, 6m	309, 310, 311, 312,	120 lm	
	Aluminium Seitenführung B11 weiss, 6lm	313	120 lm	
	Направляющая B11 алюминиевая белая		120 м	
B7-2003-001	Belka obciążająca aluminiowa biała, 6m	001, 002, 111, 308,	180 mb	
	Aluminium bottom bar white, 6m	309, 310, 311, 312,	180 lm	
	Aluminium Unterleiste, 6lm	313	180 lm	
	Планка нижняя алюминиевая белая, 6м		180 м	
B11-1009-001	Napęd B11, biały	001, 002, 111, 308,	25 kpl	
	Spring mechanism B11, white	309, 310, 311, 312,	25 set	
	Antrieb B11 weiss	313	25 kpl	
	Механизм управления B11 белый		25 компл	
B11-1109-001	Napęd B11 ze spowalniczem, biały	001, 002, 111, 308,	25 kpl	
	Spring mechanism B11 with speed reducer, white	309, 310, 311, 312,	25 set	
	64Antrieb B11 mit Slowanlage, weiss	313	25 kpl	
	Механизм В -11 с редуктором, белый		25 компл	
BW-0001-000	Blachowkręt 2,9 x12	000	1000 szt	
	Screw 2,9 x12		1000 pcs	
	Schraube 2,9 x 12		1000 st	
	Шуруп 2,9 x 12		1000 шт	
BW-0004-000	Blachowkręt 2,2 x6,5	000	1000 szt	
	Screw 2,2x6,5		1000 pcs	
	Schraube 2,2 x 6,5		1000 st	
	Шуруп 2,2 x 6,5		1000 шт	
B11-5100-001	Reduktor prędkości 25mm	001, 002, 111, 308,	25 szt	
	Speed reducer 25mm	309, 310, 311, 312,	25 pcs	
	Geschwindigkeit Reduktor 25 mm	313	25 st	
	Редуктор скорости 25мм		25 шт	

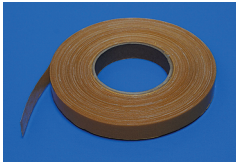
Kod Code Code Код	Nazwa Name Bezeichnung Название	Kolor Colour Farbe Цвет	Pakowanie Packing Packen Упаковка	
B11-5200-001	Reduktor prędkości 25 mm z ogranicznikiem	001, 002, 111, 308,	25 szt	
	Speed reducer 25 mm with stopper	309, 310, 311, 312,	25 pcs	
	Geschwindigkeit Reduktor 25 mm weiss mit Stoper	313	25 st	
	Редуктор скорости 25мм с ограничителем		25 шт	

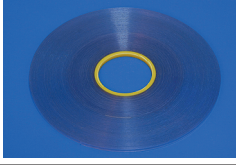
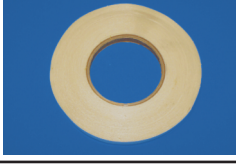
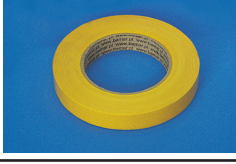
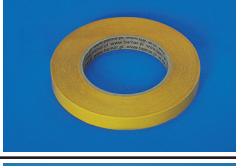
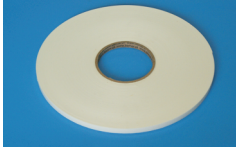
Kod Code Code Код	Nazwa Name Bezeichnung Название	Szerokość Width Breite Ширина	Pakowanie Packing Packen Упаковка	
DW-19/50	Taśma dwustronna wzmocniona	9, 12, 15, 19, 25, 38	1 szt	
	Strengthened double-sided tape		1 pcs	
	Doppelseitiges verstärktes Klebeband		1st	
	Лента двухсторонняя укреплённая		1 шт	
TP-15/50	Taśma piankowa	8, 9, 12, 15, 19	1 szt	
	Foam tape		1 pcs	
	Schaumklebeband		1st	
	Лента пенковая		1 шт	
LM-7/100	Listwa mocująca z klejem	4, 6, 7, 8, 9, 17	1 szt	
	Fastening belt with glue		1 pcs	
	Befestigungsleiste mit Kleber		1st	
	Полоска для крепления с клеем		1 шт	
TF-15/50	Taśma dwustronna na flizelinie,	9, 12, 15, 19	1 szt	
	Flizeline double-sides tape		1 pcs	
	Doppelseitiges Klebeband,		1st	
	Лента двухсторонняя на флизелине		1 шт	
NDW-19/50	Taśma dwustronna wzmocniona	15, 19	1 szt	
	Strengthened double-sided tape		1 pcs	
	Doppelseitiges verstärktes Klebeband		1st	
	Лента двухсторонняя укреплённая		1 шт	
NTF-15/50	Taśma dwustronna na flizelinie,	12, 15, 19	1 szt	
	Flizeline double-sides tape		1 pcs	
	Doppelseitiges Klebeband,		1st	
	Лента двухсторонняя на флизелине		1 шт	
NTP-15/40	Taśma piankowa	9, 15, 19	1 szt	
	Foam tape		1 pcs	
	Schaumklebeband		1st	
	Лента пенковая		1 шт	