

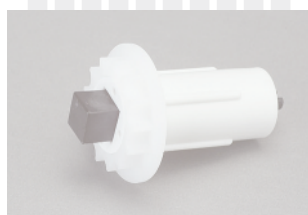

[www.bamar.pl](http://www.bamar.pl)

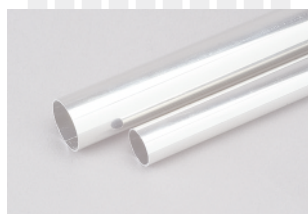
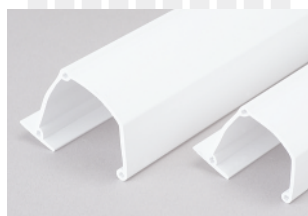

---

**BAMAR 25**

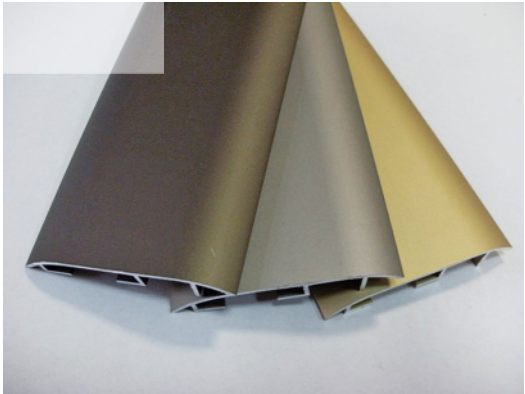

# BAMAR-25

## ALU

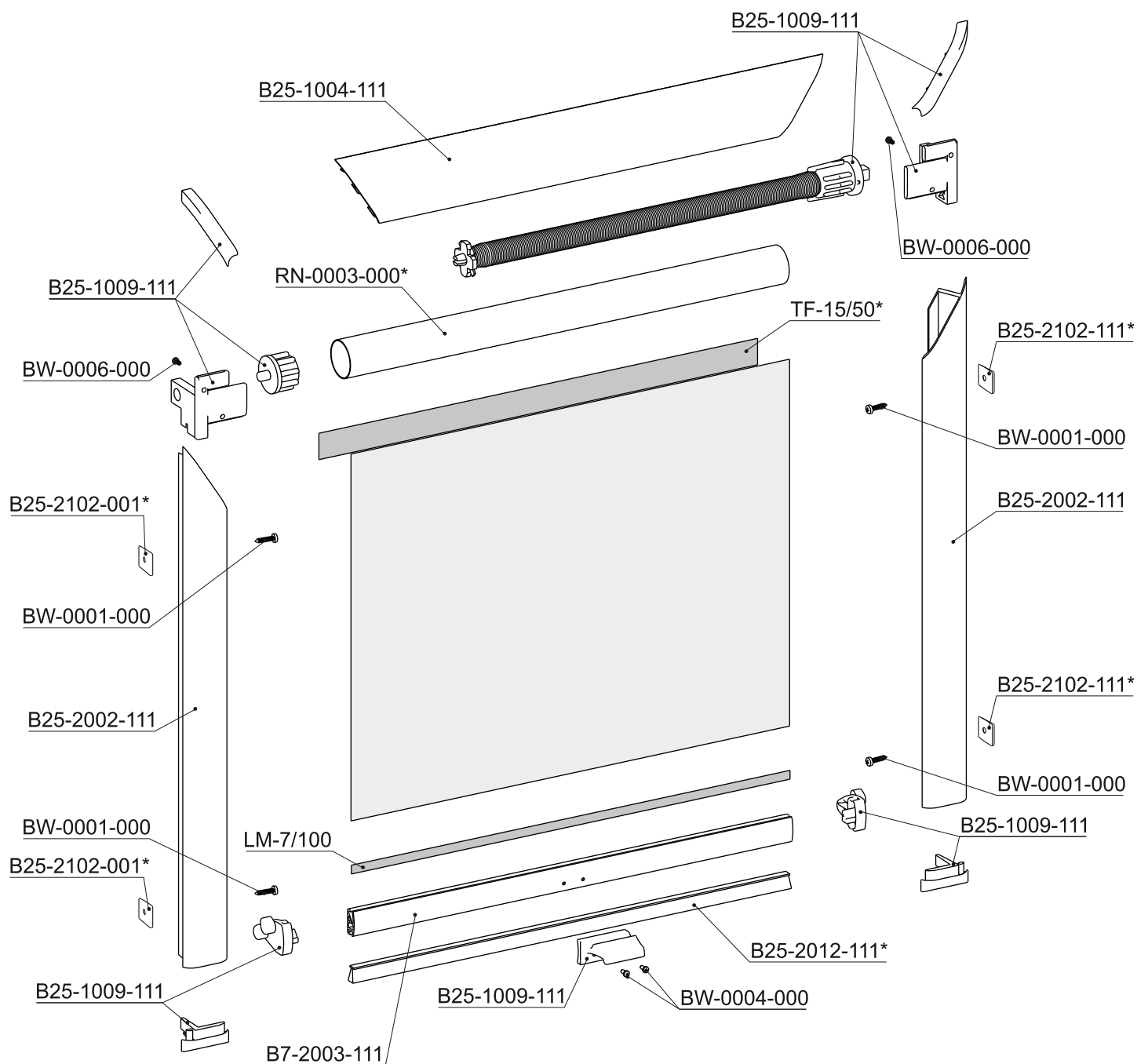

*	↻
RN-0003-000	RN-0007-000
BW-0001-000	BW-0002-000
B25-2102-001	B25-2103-001
TF-15/50	DW-19/50, NTF-15/50, NDW-19/50





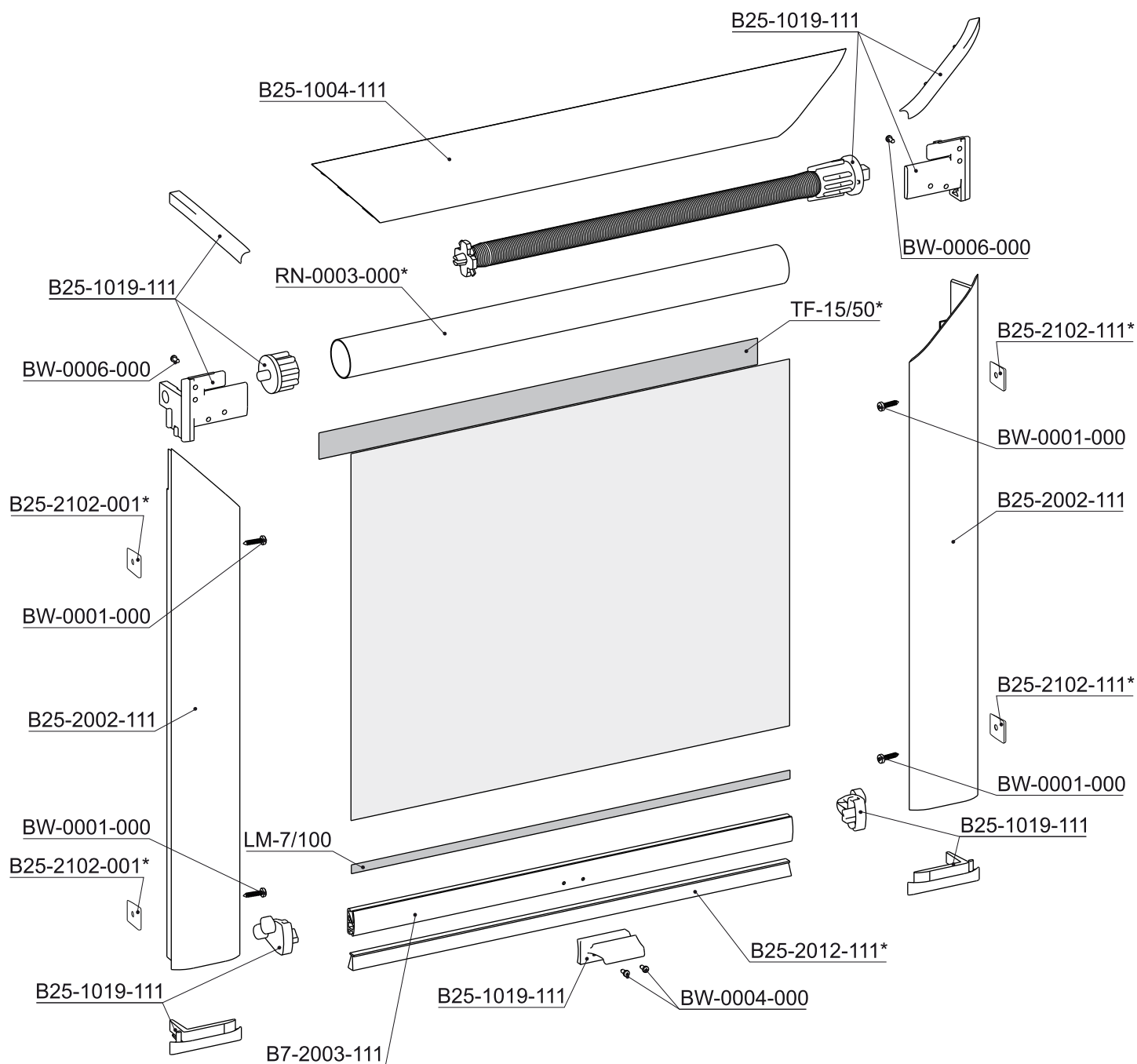

# BAMAR-25

## ALU

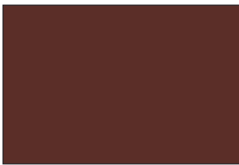
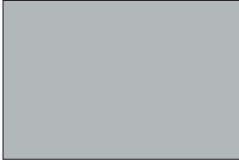







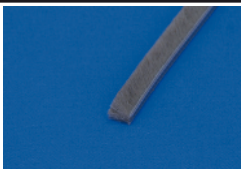

*	↻
RN-0003-000	RN-0007-000
BW-0001-000	BW-0002-000
B25-2102-001	B25-2103-001
TF-15/50	DW-19/50, NTF-15/50, NDW-19/50

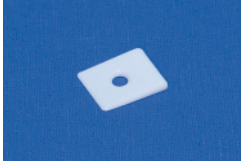
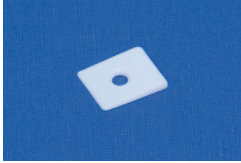
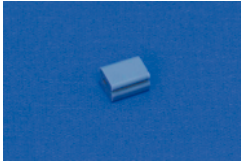

## BAMAR 25:

Kod Code Code Код	Kolor	Colour	Farbe	Цвет	
001	biały	white	weiss	белый	
002	brązowy	brown	braun	коричневый	
111	srebrny	silver	silber	серебристый	
115	złoty	gold	gold	золото	
116	brązowy matowy	brown mat	braun matt	коричневый матовый	
117	srebrny matowy	silver mat	silber matt	серебристый матовый	
305	jasna sosna	light pine	kiefer-hell	светлая sosna	
306	ciemna sosna	dark pine	kiefer-dunkel	тёмная sosna	

Kod Code Code Код	Nazwa Name Bezeichnung Название	Kolor Colour Farbe Цвет	Pakowanie Packing Packen Упаковка	
<b>B25-1004-001</b>	Maskownica Dekolux biała, 6m Covering slat Dekolux white, 6m Dekolux Blende weiss, 6m Крышка маскирующая Dekolux белая, 6м	001, 002, 111, 115, 116, 117, 305, 306	60/36 mb 60/36 lm 60/36 lm 60/36 м	
<b>RN-0003-000</b>	Rura aluminiowa, 25,0 x 0,7, 6m Aluminium tube 25,0x0,7, 6m Aluminiumrohr 25,0 x 0,7, 6m Труба алюминиевая 25,0 x 0,7 6м	000	60 mb 60 lm 60 lm 60 м	
<b>RN-0007-000</b>	Rura aluminiowa 26,3 x 1,15, 6m Aluminium tube 26,3x1,15, 6m Aluminiumrohr 26,3 x 1,15, 6m Труба алюминиевая 26,3 x 1,15, 6м	000	60 mb 60 lm 60 lm 60 м	
<b>B25-2002-001</b>	Prowadnica Dekolux biała, 6m Side guide Dekolux White, 6m Seitenführung Dekolux weiss, 6m Направляющая Dekolux белая, 6м	001, 002, 111, 115, 116, 117, 305, 306	60 mb 60 lm 60 lm 60 м	
<b>B25-2001-001</b>	Prowadnica Dekolux biała szeroka, 6m Side guide Dekolux white wide, 6m Seitenführung Dekolux weiss, breit 6m Направляющая Dekolux белая широкая, 6м	001, 002, 111, 115, 116, 117, 305, 306	60 mb 60 lm 60 lm 60 м	
<b>B7-2003-001</b>	Belka obciążająca aluminiowa biała, 6m Aluminium bottom bar white, 6m Aluminium Unterleiste, 6m Планка нижняя алюминиевая белая, 6м	001, 002, 111, 115, 116, 117, 305, 306	180/36 mb 180/36 lm 180/36 lm 180/36 м	
<b>B25-1009-111</b>	Komplet części Dekolux wąski Dekolux component set narrow Komponenten Dekolux Set Комплект компонентов Dekolux узкий	001, 002, 111, 115, 116, 117, 305, 306	25 kpl 25 set 25 kpl 25 компл	
<b>B25-1019-111</b>	Komplet części Dekolux szeroki Dekolux component set wide Komponenten Dekolux Set breit Комплект компонентов Dekolux широкий	001, 002, 111, 115, 116, 117, 305, 306	25 kpl 25 set 25 kpl 25 компл	
<b>B25-2011-111</b>	Szczotka przeciwkurzowa 4,8 x 13,0 Antidust brush 4,8 x 13,0 Antistaubbürste 4,8 x 13,0 Щётка 4,8 x 13,0	111	250 m. 250 lm 250 lm 250 м	
<b>B25-2012-111</b>	Szczotka przeciwkurzowa 4,8 x 9,0 Antidust brush 4,8 x 9,0 Antistaubbürste 4,8 x 9,0 Щётка 4,8 x 9,0	111	250 m. 250 lm 250 lm 250 м	

Kod Code Code Код	Nazwa Name Bezeichnung Название	Kolor Colour Farbe Цвет	Pakowanie Packing Packen Упаковка	
<b>B25-2013-111</b>	Szczotka przeciwkurzowa EC 4.0x9 Brush EC 4,0x9 Antistaub Bürste EC 4,0x9 Щётка EC 4.0x9	111	225 mb 225 Lm 225 Lm 225 м	
<b>BW-0001-000</b>	Blachowkręt 2,9 x12 Screw 2,9 x12 Schraube 2,9 x 12 Шуруп 2,9 x 12	000	1000 szt 1000 pcs 1000 st 1000 шт	
<b>BW-0004-000</b>	Blachowkręt 2,2 x6,5 Screw 2,2x6,5 Schraube 2,2 x 6,5 Шуруп 2,2 x 6,5	000	1000 szt 1000 pcs 1000 st 1000 шт	
<b>BW-0006-000</b>	Blachowkręt 2,2 x4,5 Screw 2,2x4,5 Schraube 2,2 x 4,5 Шуруп 2,2 x 4,5	000	1000 szt 1000 pcs 1000 st 1000 шт	
<b>B11-1022-001</b>	Mechanizm sprężynowy duży 264 mm Spring mechanism large 264 mm Federmechanismus gross 264 mm Пружина большая 264мм	001	25 szt 25 pcs 25 st 25 шт	
<b>B21-1027-010</b>	Kluczyk Key Schlüssel Ключик	010	25 szt 25 pcs 25 st 25 шт	
<b>B25-2102-001</b>	Klin korygujący 6° PVC spacer 6° Ausgleichwinkelkeil 6° Клин направляющий 6°	001	420 szt 420 pcs 420 st 420 шт	
<b>B25-2103-001</b>	Klin korygujący 4° PVC spacer 4° Ausgleichwinkelkeil 4° Клин направляющий 4°	001	420 szt 420 pcs 420 st 420 шт	
<b>B25-1104-111</b>	Element dystansowy Distancing element Abstandelement Элемент дистансовый	111	25 szt 25 pcs 25 st 25 шт	
<b>B11-2317-111</b>	Uchwyt regulacyjny Extention pole handle Griff Наконечник ручки телескоповой	111	1 szt 1 pcs 1 st 1 шт	

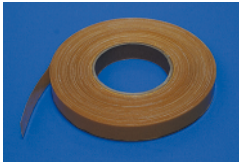
Kod Code Code Код	Nazwa Name Bezeichnung Название	Kolor Colour Farbe Цвет	Pakowanie Packing Packen Упаковка	
B11-2318-000	Uchwyt teleskopowy	000	1 szt	
	Extention pole		1 pcs	
	Teleskopbedienung		1 st	
	Ручка телескоповая		1 шт	

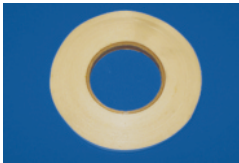
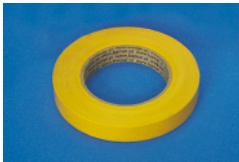
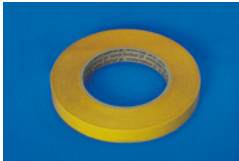
Kod Code Code Код	Nazwa Name Bezeichnung Название	Szerokość Width Breite Ширина	Pakowanie Packing Packen Упаковка	
DW-19/50	Taśma dwustronna wzmocniona	9, 12, 15, 19, 25, 38	1 szt	
	Strengthened double-sided tape		1 pcs	
	Doppelseitiges verstärktes Klebeband		1st	
	Лента двухсторонняя укреплённая		1 шт	
LM-7/100	Listwa mocująca z klejem	4, 6, 7, 8, 9, 17	1 szt	
	Fastening belt with glue		1 pcs	
	Befestigungsleiste mit Kleber		1st	
	Полоска для крепления с клеем		1 шт	
TF-15/50	Taśma dwustronna na flizelinie,	9, 12, 15, 19, 19	1 szt	
	Flizeline double-sides tape		1 pcs	
	Doppelseitiges Klebeband,		1st	
	Лента двухсторонняя на флизелине		1 шт	
NDW-19/50	Taśma dwustronna wzmocniona	15, 19	1 szt	
	Strengthened double-sided tape		1 pcs	
	Doppelseitiges verstärktes Klebeband		1st	
	Лента двухсторонняя укреплённая		1 шт	
NTF-15/50	Taśma dwustronna na flizelinie,	12, 15, 19	1 szt	
	Flizeline double-sides tape		1 pcs	
	Doppelseitiges Klebeband,		1st	
	Лента двухсторонняя на флизелине		1 шт	



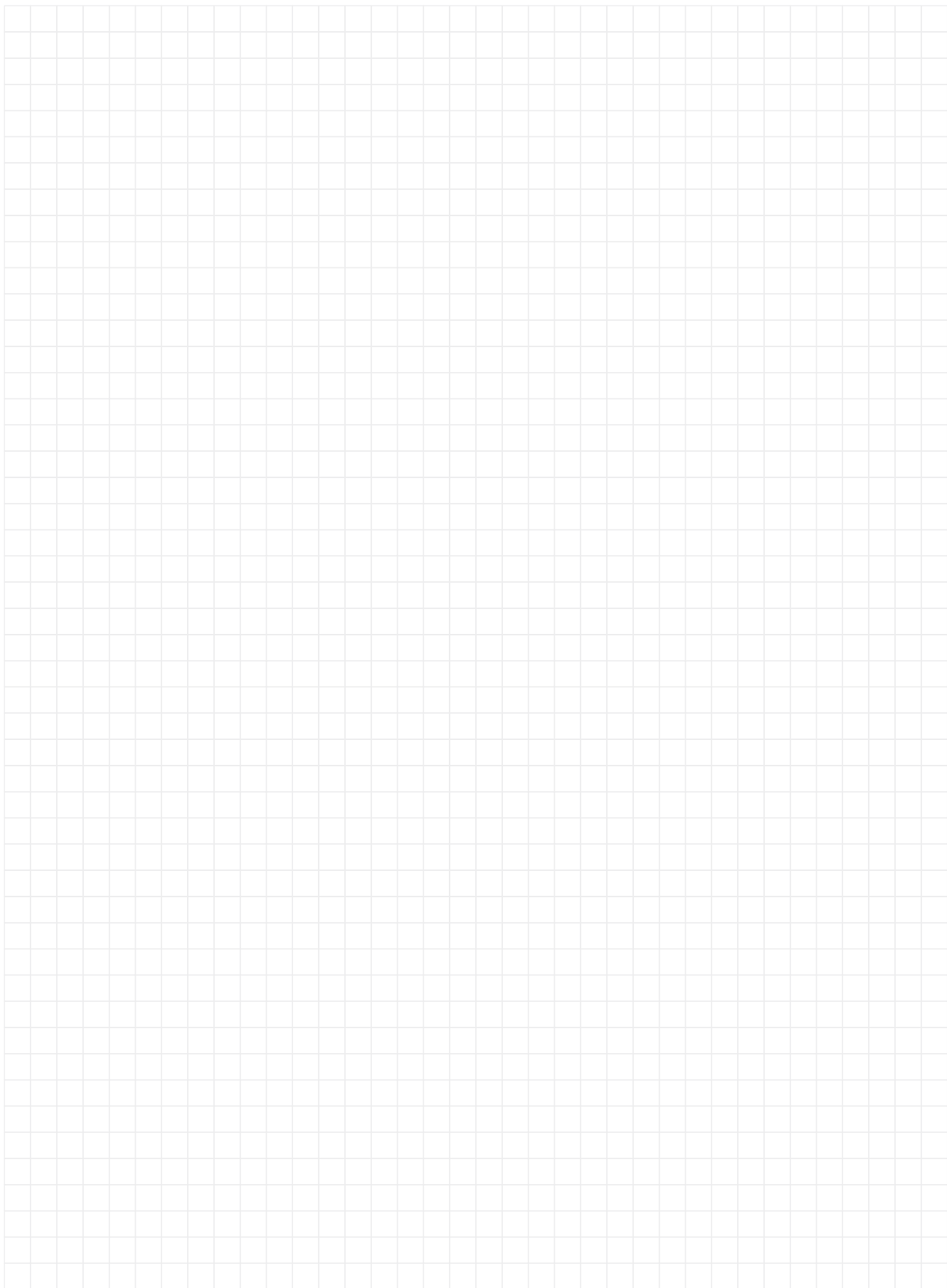

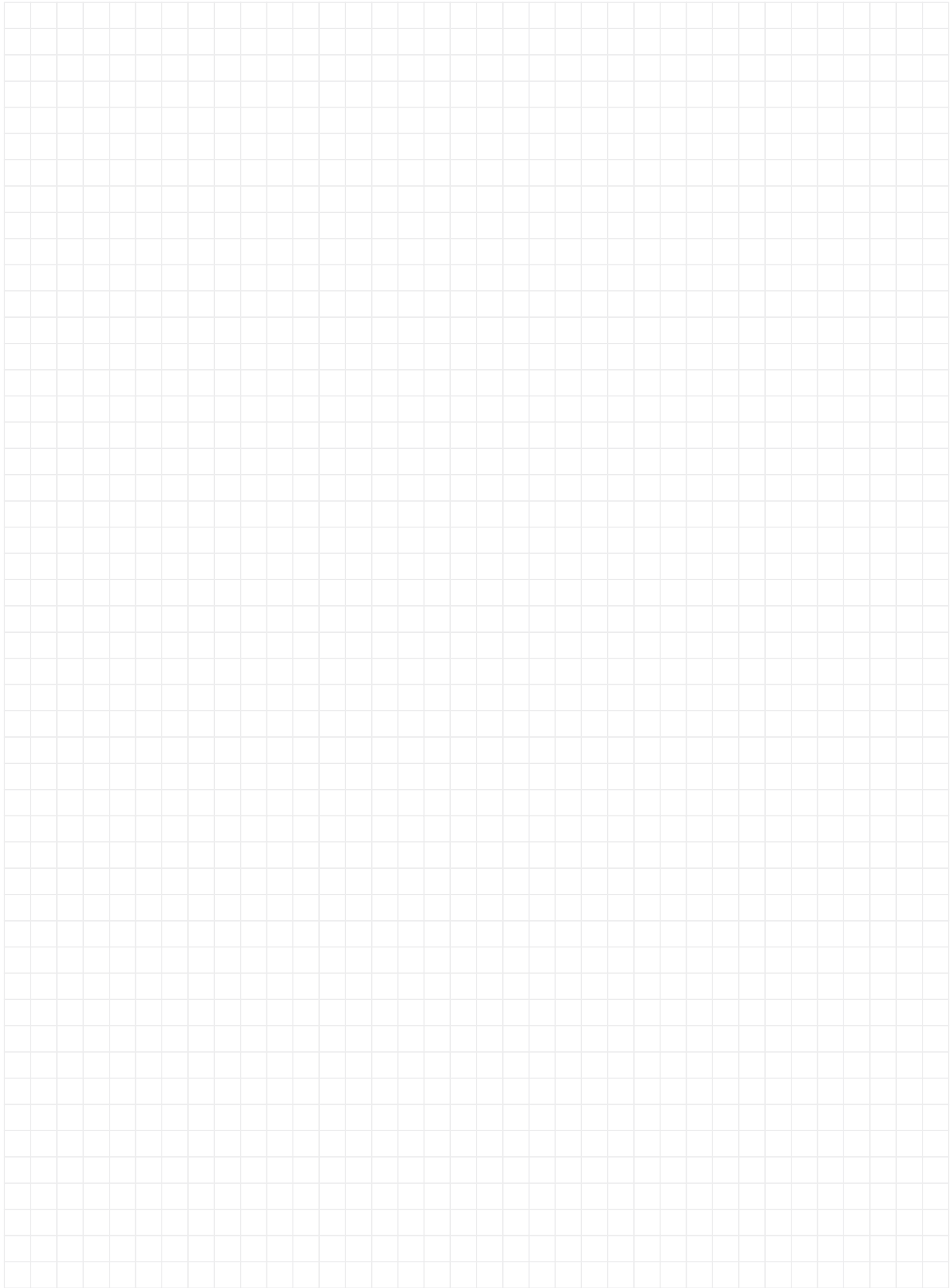

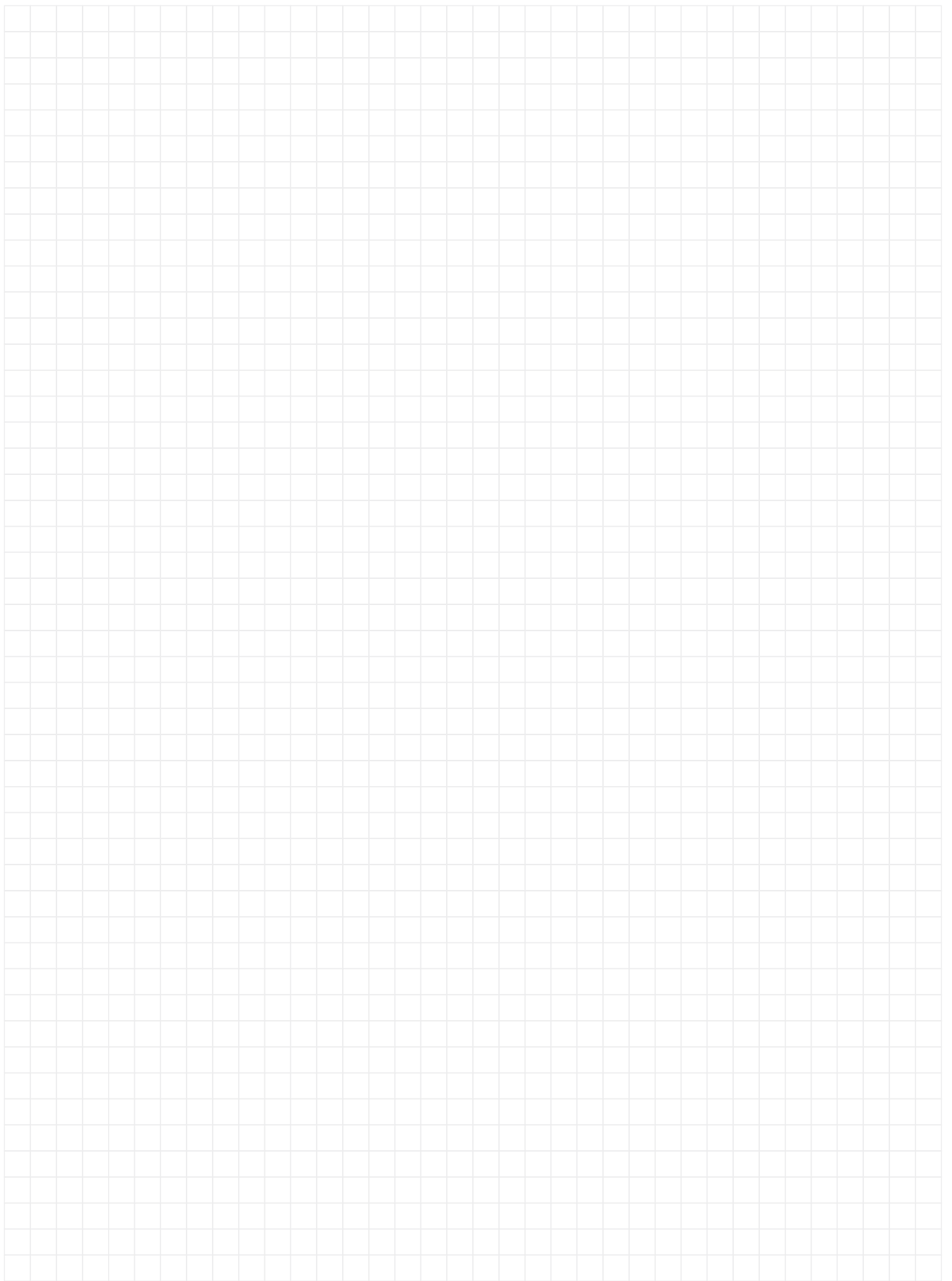

**SIEDZIBA / OFFICE**

46-024 Jełowa POLAND  
ul. Dworcowa 20  
tel.: +48 77 421 13 71  
tel.: +48 77 427 01 10  
fax: +48 77 421 14 28

**MARKETING / DZIAŁ HANDLOWY**

tel.: +48 77 427 01 10  
fax: +48 77 421 14 28  
e-mail: marketing@bamar.pl  
e-mail: handlowy@bamar.pl

**MAGAZYN / WAREHOUSE**

47-100 Strzelce Opolskie POLAND  
ul. 1-go Maja 50  
tel./fax +48 77 404 95 15  
e-mail: jan-strz@bamar.pl  
e-mail: magazyn@bamar.pl

**EXPORT**

tel.: +48 77 427 01 00  
fax: +48 77 427 01 01  
e-mail: export@bamar.pl