

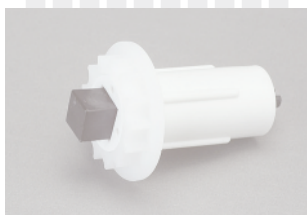

www.bamar.pl

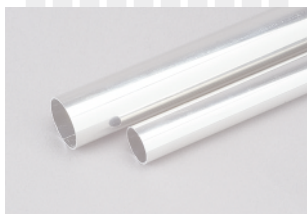

BAMAR 35



BAMAR-35



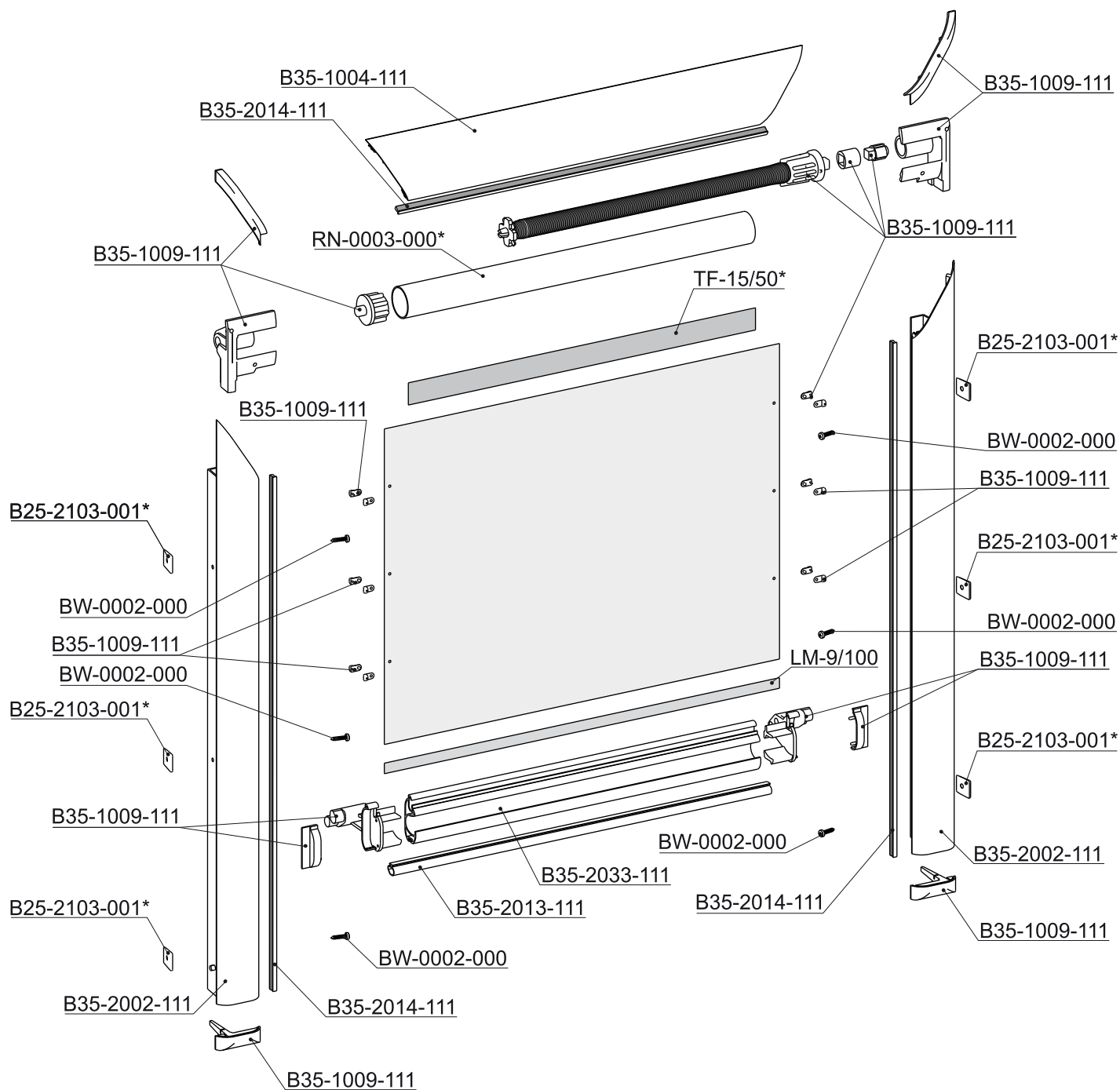



ALU

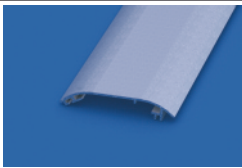

*	↻
RN-0003-000	RN-0007-000
B25-2103-001	B25-2102-001
TF-15/50	DW-19/50, NTF-15/50, NDW-19/50

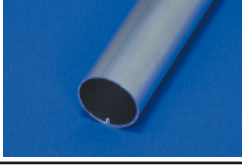
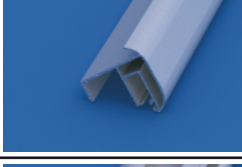
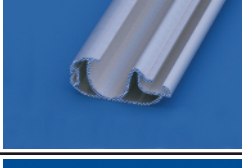
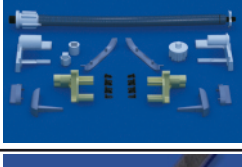
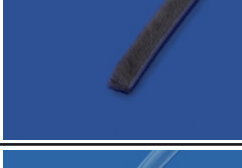
BAMAR 35:

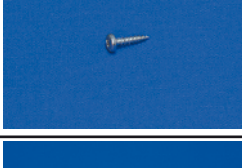
Kod Code Code Код	Kolor	Colour	Farbe	Цвет	
111	srebrny	silver	silber	серебристый	

Kod Code Code Код	Nazwa Name Bezeichnung Название	Kolor Colour Farbe Цвет	Pakowanie Packing Packen Упаковка	
B35-1004-111	Maskownica B-35, 6m Covering slat B-35, 6m Blende B-35, 6m Крышка маскирующая B-35, 6м	111	60 mb 60 lm 60 lm 60 м	
RN-0003-000	Rura aluminiowa, 25,0 x 0,7, 6m Aluminium tube 25,0x0,7, 6m Aluminiumrohr 25,0 x 0,7, 6m Труба алюминиевая 25,0 x 0,7 6м	000	60 mb 60 lm 60 lm 60 м	
RN-0007-000	Rura aluminiowa 26,3 x 1,15, 6m Aluminium tube 26,3x1,15, 6m Aluminiumrohr 26,3 x 1,15, 6m Труба алюминиевая 26,3 x 1,15, 6м	000	60 mb 60 lm 60 lm 60 м	
B35-2002-111	Prowadnica B-35, 6m Side guide B-35, 6m Seitenführung B35, 6m Направляющая B-35 алюминиевая, 6м	111	60 mb 60 lm 60 lm 60 м	
B35-2033-111	Belka dolna B-35, 6m Alu bottom bar B35, 6m Unterleiste B35, 6m Планка нижняя B-35 алюминиевая, 6м	111	60 mb 60 lm 60 lm. 60 м	
B35-1009-111	Komplet części B35 B35 component set Komponentenset B35 Комплект компонентов B35	111	25 kpl 25 set 25 kpl 25 компл	
B35-2014-111	Szczotka przeciwkurzowa 3,5x5 Brush 3,5x5 Antistaub Bürste 3,5x5 Щётка 3,5x5	111	150 mb 150 Lm 150 Lm 150 м	
B35-2013-111	Uszczelka B35, szara Seal B35 grey B35 Dichtung, grau Уплотнитель B35, серый	111	200 mb 200 Lm 200 Lm 200 м	
BW-0002-000	Blachowkręt 2,9 x16 Screw 2,9 x16 Schraube 2,9 x 16 Шуруп 2,9 x 16	000	1000 szt 1000 pcs 1000 st 1000 шт	
B11-1022-001	Mechanizm sprężynowy duży 264 mm Spring mechanism large 264 mm Federmechanismus gross 264 mm Пружина большая 264мм	001	25 szt 25 pcs 25 st 25 шт	

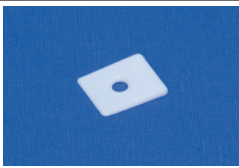
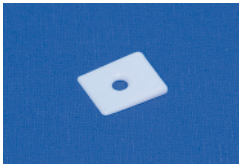
Kod Code Code Код	Nazwa Name Bezeichnung Название	Kolor Colour Farbe Цвет	Pakowanie Packing Packen Упаковка	
B25-2102-001	Klin korygujący 6°	001	420 szt	
	PVC spacer 6°		420 pcs	
	Ausgleichwinkelkeil 6°		420 st	
	Клин направляющий 6°		420 шт	
B25-2103-001	Klin korygujący 4°	001	420 szt	
	PVC spacer 4°		420 pcs	
	Ausgleichwinkelkeil 4°		420 st	
	Клин направляющий 4°		420 шт	

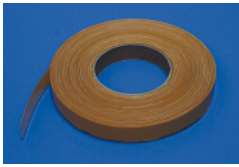
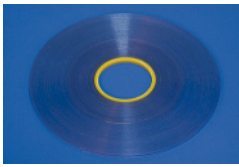
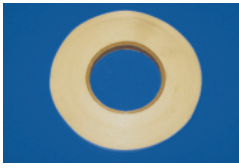
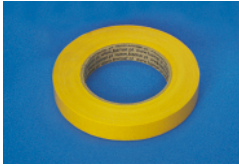
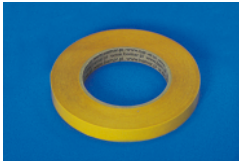
Kod Code Code Код	Nazwa Name Bezeichnung Название	Szerokość Width Breite Ширина	Pakowanie Packing Packen Упаковка	
DW-19/50	Taśma dwustronna wzmocniona	9, 12, 15, 19, 25, 38	1 szt	
	Strengthened double-sided tape		1 pcs	
	Doppelseitiges verstärktes Klebeband		1st	
	Лента двухсторонняя укреплённая		1 шт	
LM-9/100	Listwa mocująca z klejem	4, 6, 7, 8, 9, 17	1 szt	
	Fastening belt with glue		1 pcs	
	Befestigungsleiste mit Kleber		1st	
	Полоска для крепления с клеем		1 шт	
TF-15/50	Taśma dwustronna na flizelinie,	9, 12, 15, 19, 19	1 szt	
	Flizeline double-sides tape		1 pcs	
	Doppelseitiges Klebeband,		1st	
	Лента двухсторонняя на флизелине		1 шт	
NDW-19/50	Taśma dwustronna wzmocniona	15, 19	1 szt	
	Strengthened double-sided tape		1 pcs	
	Doppelseitiges verstärktes Klebeband		1st	
	Лента двухсторонняя укреплённая		1 шт	
NTF-15/50	Taśma dwustronna na flizelinie,	12, 15, 19	1 szt	
	Flizeline double-sides tape		1 pcs	
	Doppelseitiges Klebeband,		1st	
	Лента двухсторонняя на флизелине		1 шт	

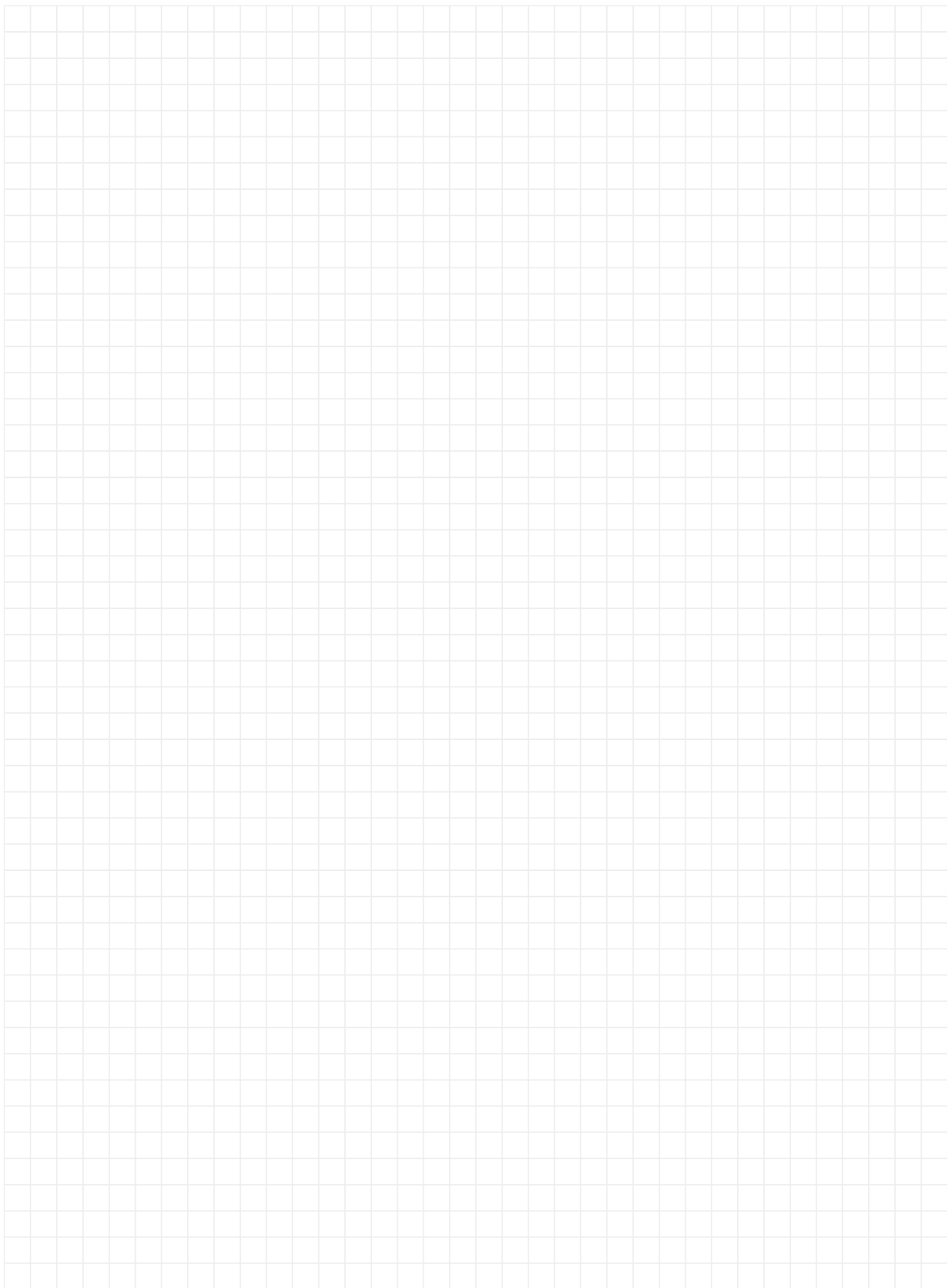

**SIEDZIBA / OFFICE**

46-024 Jełowa POLAND
ul. Dworcowa 20
tel.: +48 77 421 13 71
tel.: +48 77 427 01 10
fax: +48 77 421 14 28

MARKETING / DZIAŁ HANDLOWY

tel.: +48 77 427 01 10
fax: +48 77 421 14 28
e-mail: marketing@bamar.pl
e-mail: handlowy@bamar.pl

MAGAZYN / WAREHOUSE

47-100 Strzelce Opolskie POLAND
ul. 1-go Maja 50
tel./fax +48 77 404 95 15
e-mail: jan-strz@bamar.pl
e-mail: magazyn@bamar.pl

EXPORT

tel.: +48 77 427 01 00
fax: +48 77 427 01 01
e-mail: export@bamar.pl