

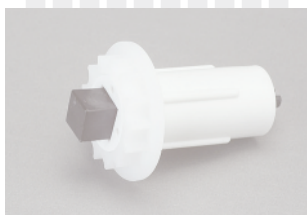

[www.bamar.pl](http://www.bamar.pl)

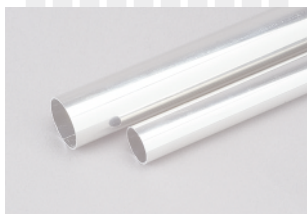

---

# BAMAR 39



# SYSTEM B-39 / D&N

## PVC

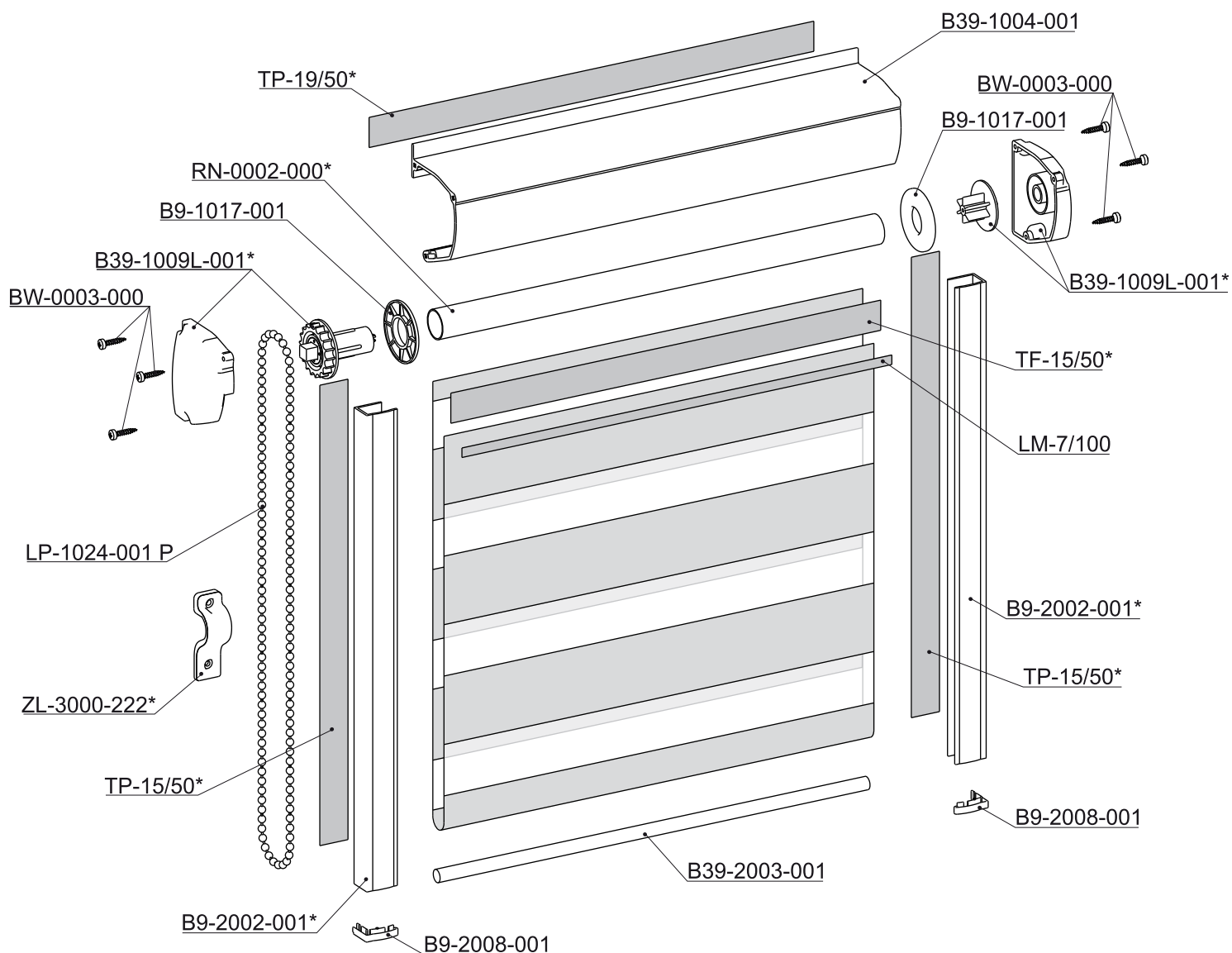

*	↻
B9-2002-001	B9-2001-001, B9-1001-001, B9-1001-001+
RN-0002-000	RN-0006-000
B39-1009L-001	B39-1009P-001
LP-1024-001 P	LP-1036-001 P, LP-1000-001 3.6, LP-2000-001 2.3
ZL-3000-222	UL-1000-001
TF-15/50	DW-19/50, NTF-15/50, NDW-19/50
TP-15/50	NTP-15/40





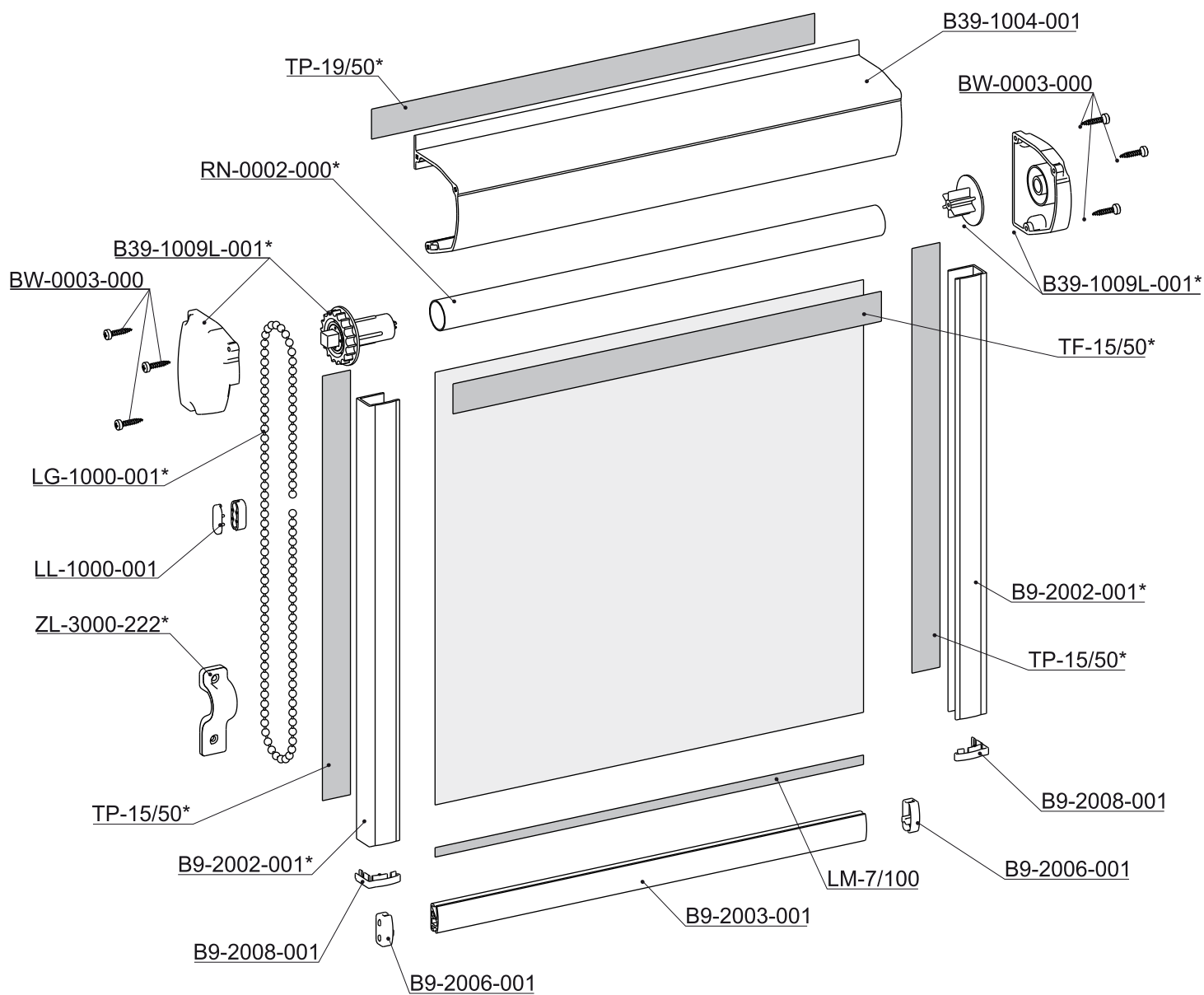

# SYSTEM B-39





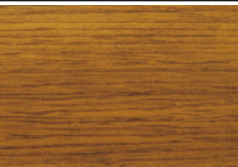
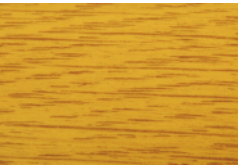
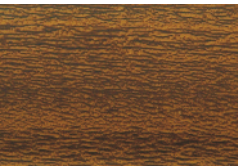
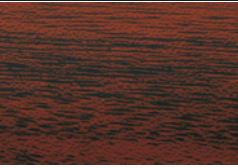



## PVC

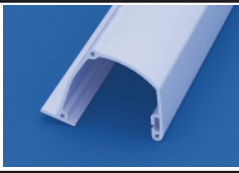

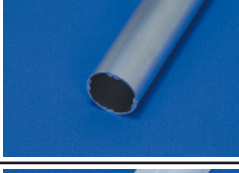

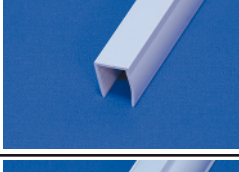
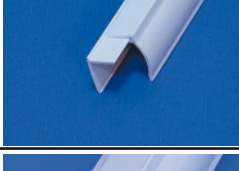
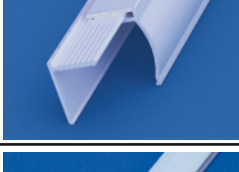





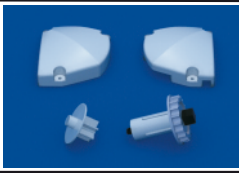
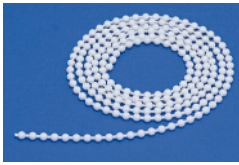



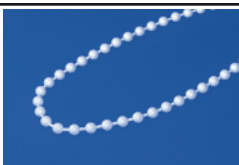
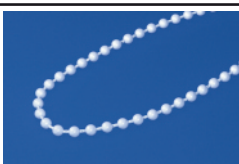

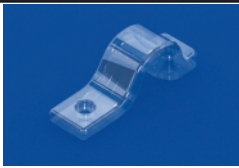

*	↻
B9-2002-001	B9-2001-001, B9-1001-001, B9-1001-001+
RN-0002-000	RN-0006-000
B39-1009L-001	B39-1009P-001
LG-1000-001	LG-1000-001-P
ZL-3000-222	UL-1000-001
TF-15/50	DW-19/50, NTF-15/50, NDW-19/50
TP-15/50	NTP-15/40

## BAMAR 39:

Kod Code Code Код	Kolor	Colour	Farbe	Цвет	
001	biały	white	weiss	белый	
011	brązowy	brown	braun	коричневый	
408	dąb złoty	gold oak	eiche-gold	золотой дуб	
409	jasny dąb	light oak	eiche-hell	светлый дуб	
410	orzech	nut brown	nuss	орех	
411	mahoń	mahogany	mahagoni	махагон	
412	wisnia	cherry red	kirsche	вишня	
413	orzech wenge	wenge nut	nuss-wenge	венге	
414	antracyt	anthracite	anthrazit	антрацит	

Kod Code Code Код	Nazwa Name Bezeichnung Название	Kolor Colour Farbe Цвет	Pakowanie Packing Packen Упаковка	
<b>V39-1004-001</b>	Kaseta PCV B39, biała, 2,65m, 6m	001, 011, 408, 409,	26,5/36 mb	
	PVC cassette B39 white, 2,65m, 6m	410, 411, 412, 413,	26,5/36 lm	
	Kassette B-39 Pvc Weiss, 2,65m, 6m	414	26,5/36 lm	
	Кассета B39 ПВХ, белая, 2,65м, 6м		26,5/36 м	
<b>RN-0002-000</b>	Rura aluminiowa 18,0 x 0,65, 6m	000	60 mb	
	Aluminium tube 18,0x0,65, 6m		60 lm	
	Aluminiumrohr 18,0 x 0,65, 6m		60 lm	
	Труба алюминиевая 18,0 x 0,65, 6м		60 м	
<b>RN-0006-000</b>	Rura aluminiowa ożebrowana 19,0 x 1,1, 6m	000	60 mb	
	Aluminium tube strengthened 19,0x1,1, 6m		60 lm	
	Aluminiumrippenrohr 19,0 x 1,1, 6m		60 lm	
	Труба алюминиевая укрепленная 19,0 x 1,1, 6м		60 м	
<b>B9-2001-001</b>	Prowadnica B9 9mm, dł. 2,65m; 6m	001, 011, 408, 409,	106/53 mb	
	PVC side guide B9 9 mm, 2,65m; 6m	410, 411, 412, 413,	106/53 lm	
	PVC Seitenführung B9 9 mm, 2,65m; 6m	414	106/53 lm	
	Направляющая B9 ПВХ 9мм, 2,65м; 6м		106/53 м	
<b>B9-2001-001P</b>	Prowadnica B9 18mm, 2,65m; 6m	001, 011, 408, 409,	106/53 mb	
	PVC side guide B9 18 mm, 2,65m; 6m	410, 411, 412, 413,	106/53 lm	
	PVC Seitenführung B9 18 mm, 2,65m; 6m	414	106/53 lm	
	Направляющая B9 ПВХ 18мм, 2,65м; 6м		106/53 м	
<b>B9-2002-001P</b>	Prowadnica B9 składana, 2,65m	001	53 mb	
	PVC side guide-folding B9, 2,65m		53 lm	
	Trennbare PVC Seintenführung B9, 2,65m		53 lm	
	Направляющая B-9 составная, 2,65м		53 м	
<b>B9-1001-001+</b>	Prowadnica B9 składana szeroka, 2,65m	001, 002	53 mb	
	Folding PVC side guide B9 wide, 2,65m		53 lm	
	Trennbare B9 PVC Seitenführung breit, 2,65m		53 lm	
	Направляющая B9 ПВХ составная широкая, 2,65м		53 м	
<b>B9-2003-001</b>	Belka dolna PCV, 2,65m	001, 011, 408, 409,	106/26,5 mb	
	PVC bottom bar, 2,65m	410, 411, 412, 413,	106/26,5 lm	
	PVC Unterleiste, 18 mm, 2,65m	414	106/26,5 lm	
	Планка нижняя ПВХ белая, 2,65м		106/26,5 м	
<b>V39-2003-001</b>	Pręt obciążający, biały	001, 002, 501, 502,	26,5/20 mb	
	Alu Tiltrod weight white	503, 504, 505	26,5/20 lm	
	Alu-Beschwerdestab- Weiss		26,5/20 lm	
	Прут-утяжелитель алюминиевый, белый		26,5/20 м	
<b>V39-1009L-001</b>	Napęd B39 lewy, biały	001, 011, 408, 409,	25 kpl	
	Chain mechanism B39 left white	410, 411, 412, 413,	25 set	
	Antrieb B39 weiss	414	25 kpl	
	Механизм управления B39 левый белый		25 компл	

Kod Code Code Код	Nazwa Name Bezeichnung Название	Kolor Colour Farbe Цвет	Pakowanie Packing Packen Упаковка	
<b>B39-1009P-001</b>	Napęd B39 prawy, biały	001, 011, 408, 409,	25 kpl	
	Chain mechanism B39 right white	410, 411, 412, 413,	25 set	
	Antrieb B39 rechts, weiss	414	25 kpl	
	Механизм управления B39 правый белый		25 компл	
<b>LG-1000-001</b>	Łańcuszek kulkowy, biały	001, 010, 011, 300,	300 m	
	Ball chain, (dense), white	414	300 lm	
	Kugelkette, weiss		300 lm	
	Цепочка шариковая, белая		300м	
<b>LG-1000-001-P</b>	Łańcuszek kulkowy Ø4,45mm, przezroczysty	001,002	250 mb	
	Ball chain Ø4,45mm transparent		250 Lm	
	Perlenkette Ø4,45 mm, transparent		250 Lm	
	Цепочка шариковая Ø4,45mm, прозрачная		250 м	
<b>LP-1024-001 P</b>	Łańcuszek pętla 2,4m, transparentny	001, 002	100 szt	
	Chain loop 2,4m transparent		100 pcs	
	Endlosekette 2,4 lm Transparent		100 st	
	Цепочка-петля, 2,4м, прозрачная		100 шт	
<b>LP-1036-001 P</b>	Łańcuszek pętla 3,6m, transparentny	001, 002	100 szt	
	Chain loop 3,6m transparent		100 pcs	
	Endlosekette 3,6 lm Transparent		100 st	
	Цепочка-петля, 3,6м, прозрачная		100 шт	
<b>LP-1000-001 2,4</b>	Łańcuszek pętla 2,4m	001, 002, 408, 411,	100 szt	
	Chain loop 2,4m	414	100 pcs	
	Endlosekette 2,4 lm		100 st	
	Цепочка-петля, 2,4м		100 шт	
<b>LP-1000-001 3,6</b>	Łańcuszek pętla 3,6m	001, 002, 411, 414	100 szt	
	Chain loop 3,6m		100 pcs	
	Endlosekette 3,6 lm		100 st	
	Цепочка-петля, 3,6м		100 шт	
<b>LP-2000-001 2,3</b>	Łańcuszek pętla 2,3m	001	100 szt	
	Chain loop 2,3m		100 pcs	
	Endlosekette 2,3 lm		100 st	
	Цепочка-петля, 2,3м		100 шт	
<b>LL-1000-001</b>	Łącznik łańcuszka, biały	001, 011, 222, 414	100 szt	
	Connection clip, white		100 pcs	
	Kugelkettverbinder, weiss		100 st	
	Соединитель цепочки, белый		100 шт	
<b>UL-1000-001</b>	Uchwyt łańcuszka, biały	001	100 szt	
	Chain handle, white		100 pcs	
	Kettengriff, weiss		100 st	
	Крепитель цепочки, белый		100 шт	

Kod Code Code Код	Nazwa Name Bezeichnung Название	Kolor Colour Farbe Цвет	Pakowanie Packing Packen Упаковка	
ZL-3000-222	Uchwyt zabezpieczający łańcuszka, bezbarwny Safety handle for chain, transparent Sicherheitsgriff für die Kette, farblos Фиксатор цепочки, прозрачный	222	100 szt 100 pcs 100 st 100 шт	
PT-1019-001	Obciążnik sznurka, biały Cordweight white Schnurbeshwerer, weiss Грузик шнура ПТ, белый	001, 111	100 szt 100 pcs 100 st 100 шт	
UL-2000-001	Obciążnik łańcuszka, biały Chain handle white Kettenbeschwerer, weiss Грузик цепочки, белый	001	100 szt 100 pcs 100 st 100 шт	
B7-2007-001	Zatyczka belki obciążającej płaska, biała End cap flat, white Endleiste Blendestopfen, weiss Заглушка нижней планки, белая	001	125 szt 125 pcs 125 st 125 шт	
B9-2006-001	Zatyczka belki B9, biały End cap B9, white Endleiste Blendestopfen B9, weiss Заглушка нижней планки B9, белая	001, 011	100 szt 100 pcs 100 st 100 шт	
B9-2008-001	Zaślepka prowadnicy B9, biała Side guide end cap, white Endkappe für Seitenführung, weiss Заглушка направляющей, белая	001, 011, 111, 301, 302, 303, 304, 414	100 szt 100 pcs 100 st 100 шт	
BW-0003-000	Blachowkręt 2,2 x16 Screw 2,2x16 Schraube 2,2 x 16 Шуруп 2,2 x 16	000, czarny	1000 szt 1000 pcs 1000 st 1000 шт	
B9-1017-001	B9 krążek prowadzący, biały Disc B9, white B9 Führungsscheibe, weiss Диск B9, белый	001	100 szt 100 pcs 100 st 100 шт	

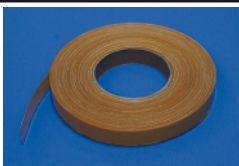
Kod Code Code Код	Nazwa Name Bezeichnung Название	Szerokość Width Breite Ширина	Pakowanie Packing Packen Упаковка	
DW-19/50	Taśma dwustronna wzmocniona Strengthened double-sided tape Doppelseitiges verstärktes Klebeband Лента двухсторонняя укреплённая	9, 12, 15, 19, 25, 38	1 szt 1 pcs 1st 1 шт	

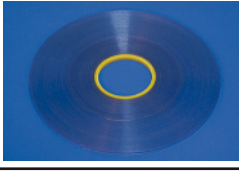
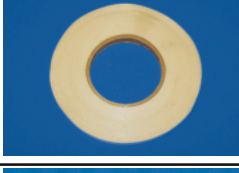
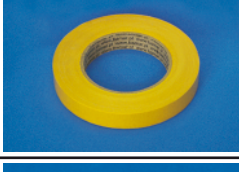
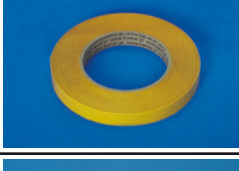
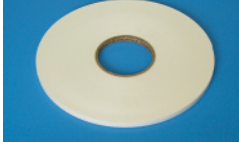

Kod Code Code Код	Nazwa Name Bezeichnung Название	Szerokość Width Breite Ширина	Pakowanie Packing Packen Упаковка	
<b>TP-15/50</b>	Taśma piankowa Foam tape Schaumklebeband Лента пенковая	8, 9, 12, 15, 19	1 szt 1 pcs 1st 1 шт	
<b>LM-7/100</b>	Listwa mocująca z klejem Fastening belt with glue Befestigungsleiste mit Kleber Полоска для крепления с клеем	4, 6, 7, 8, 9, 17	1 szt 1 pcs 1st 1 шт	
<b>TF-15/50</b>	Taśma dwustronna na flizelinie, Flizeline double-sides tape Doppelseitiges Klebeband, Лента двухсторонняя на флизелине	9, 12, 15, 19	1 szt 1 pcs 1st 1 шт	
<b>NDW-19/50</b>	Taśma dwustronna wzmocniona Strengthened double-sided tape Doppelseitiges verstärktes Klebeband Лента двухсторонняя укрепленная	15, 19	1 szt 1 pcs 1st 1 шт	
<b>NTF-15/50</b>	Taśma dwustronna na flizelinie, Flizeline double-sides tape Doppelseitiges Klebeband, Лента двухсторонняя на флизелине	12, 15, 19	1 szt 1 pcs 1st 1 шт	
<b>NTP-15/40</b>	Taśma piankowa Foam tape Schaumklebeband Лента пенковая	9, 15, 19	1 szt 1 pcs 1st 1 шт	

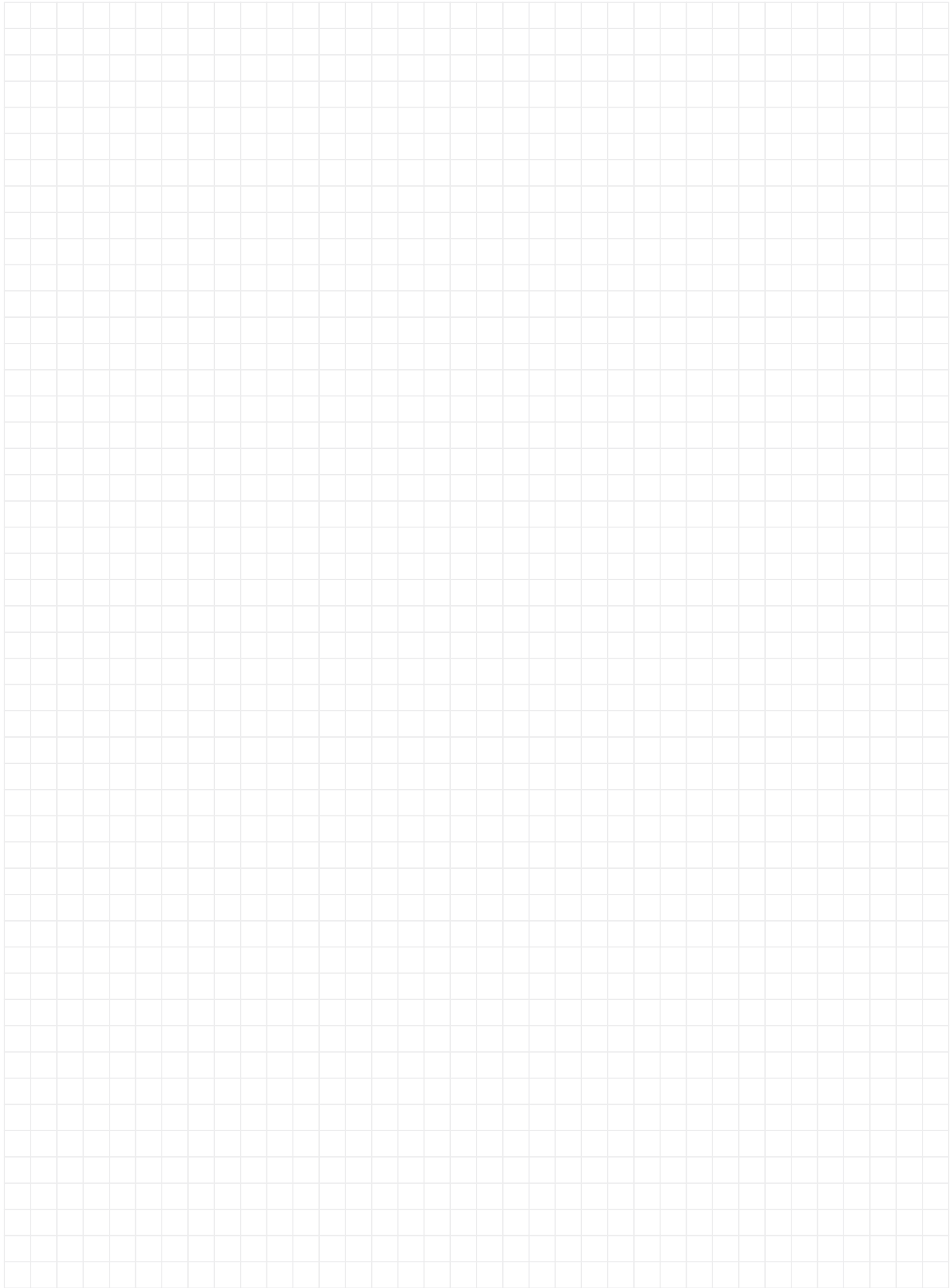

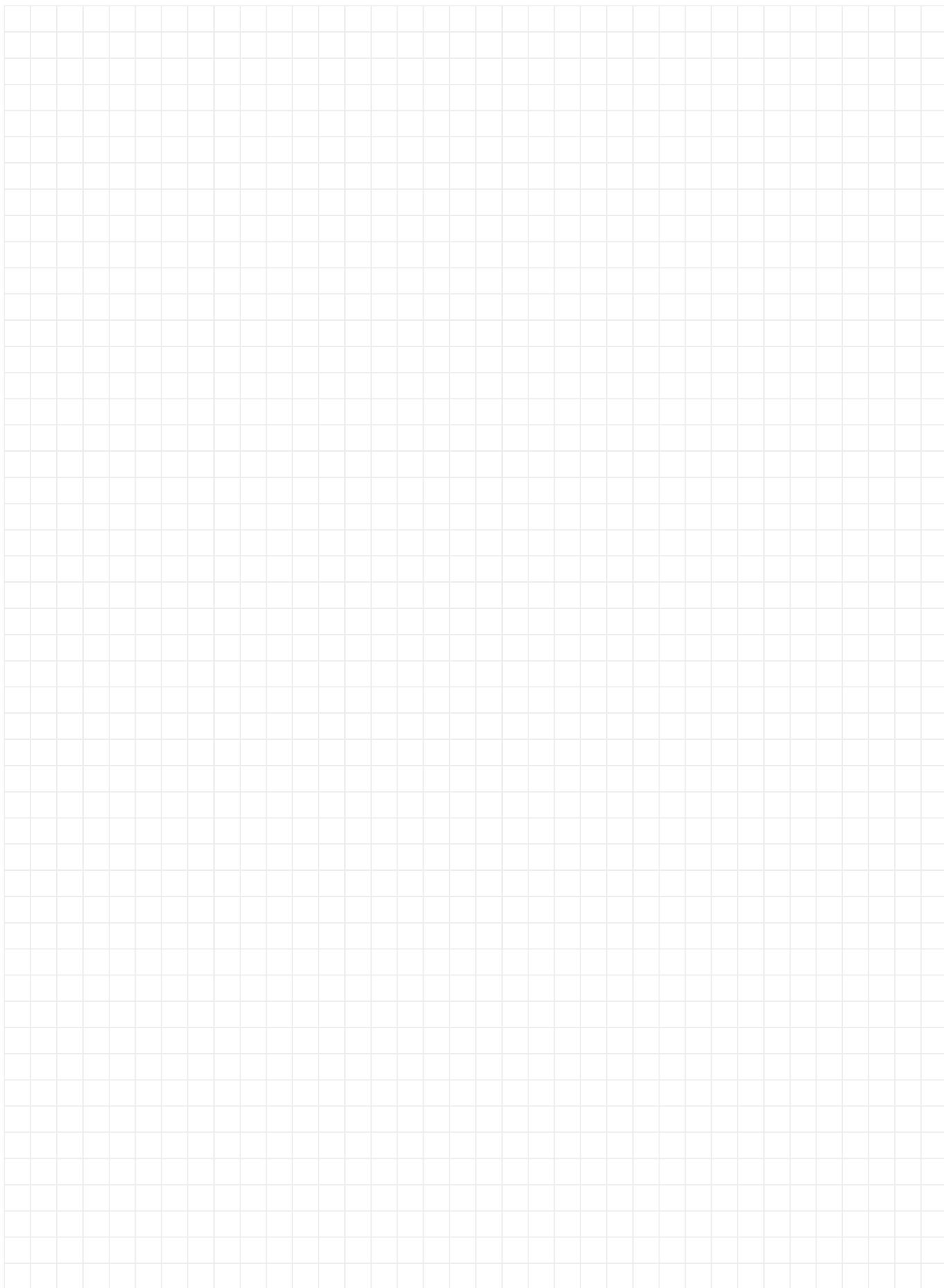

**SIEDZIBA / OFFICE**

46-024 Jełowa POLAND  
ul. Dworcowa 20  
tel.: +48 77 421 13 71  
tel.: +48 77 427 01 10  
fax: +48 77 421 14 28

**MARKETING / DZIAŁ HANDLOWY**

tel.: +48 77 427 01 10  
fax: +48 77 421 14 28  
e-mail: marketing@bamar.pl  
e-mail: handlowy@bamar.pl

**MAGAZYN / WAREHOUSE**

47-100 Strzelce Opolskie POLAND  
ul. 1-go Maja 50  
tel./fax +48 77 404 95 15  
e-mail: jan-strz@bamar.pl  
e-mail: magazyn@bamar.pl

**EXPORT**

tel.: +48 77 427 01 00  
fax: +48 77 427 01 01  
e-mail: export@bamar.pl