

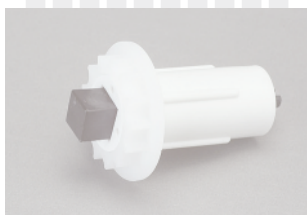

[www.bamar.pl](http://www.bamar.pl)

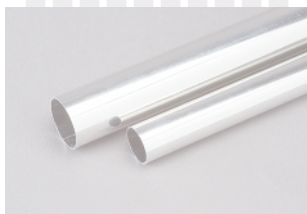

---

# BAMAR 5 D&N

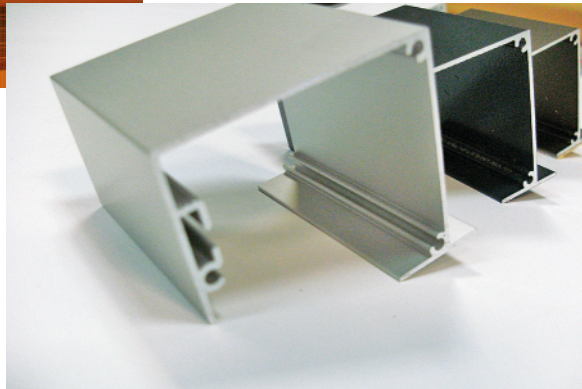

# BAMAR 5 / D&N

## ALU

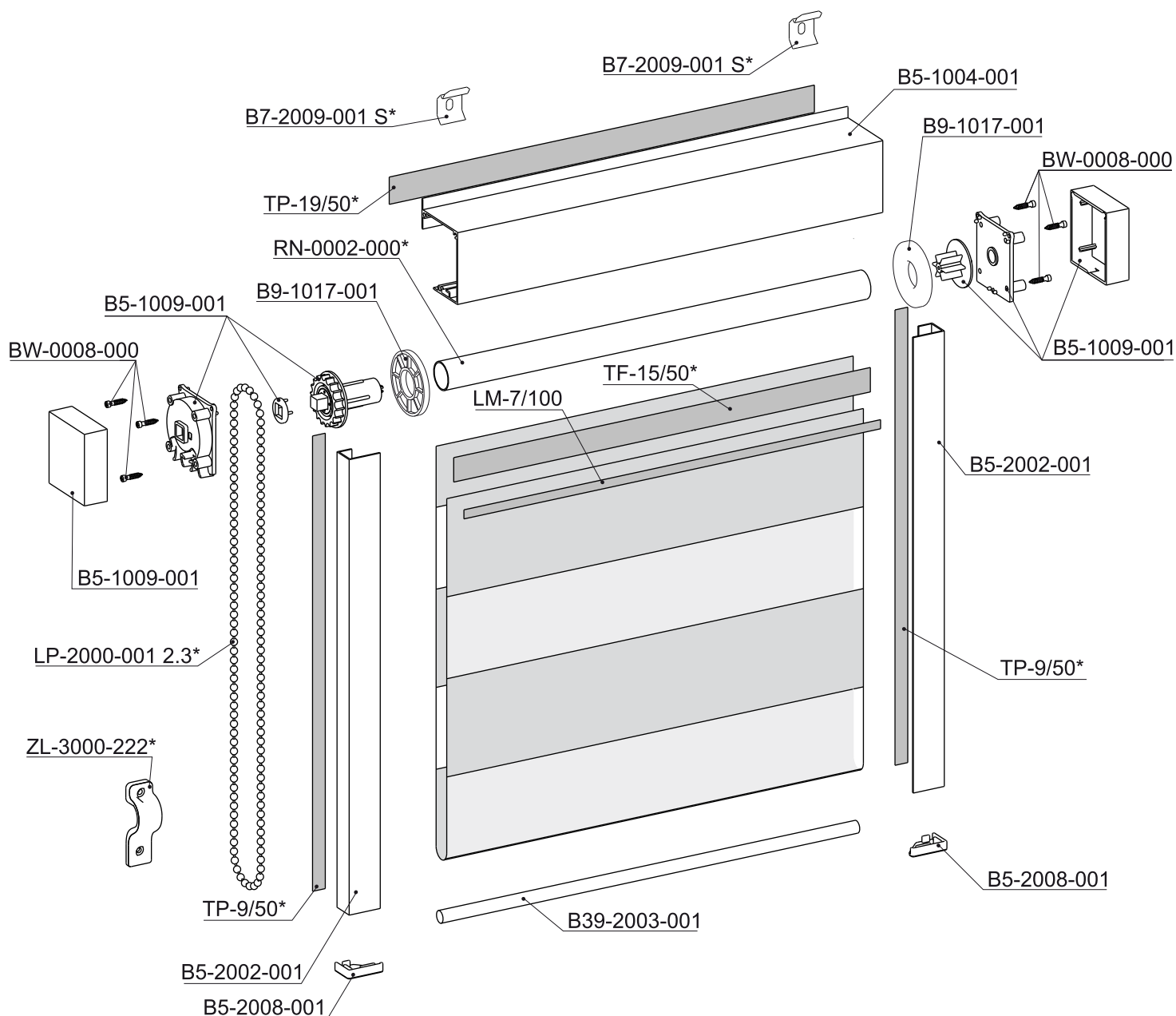

\*



RN-0002-000	RN-0006-000
LP-2000-001 2.3	LG-1000-501, LP-1000-001 2.4, LP-1000-001 3.6, LP-1024-001P, LP-1036-001P
ZL-3000-222	UL-1000-001
B7-2009-001 S	B7-2009-001
TF-15/50	DW-19/50, NTF-15/50, NDW-19/50
TP-9/50	NTP-9/40

# BAMAR 5

## ALU

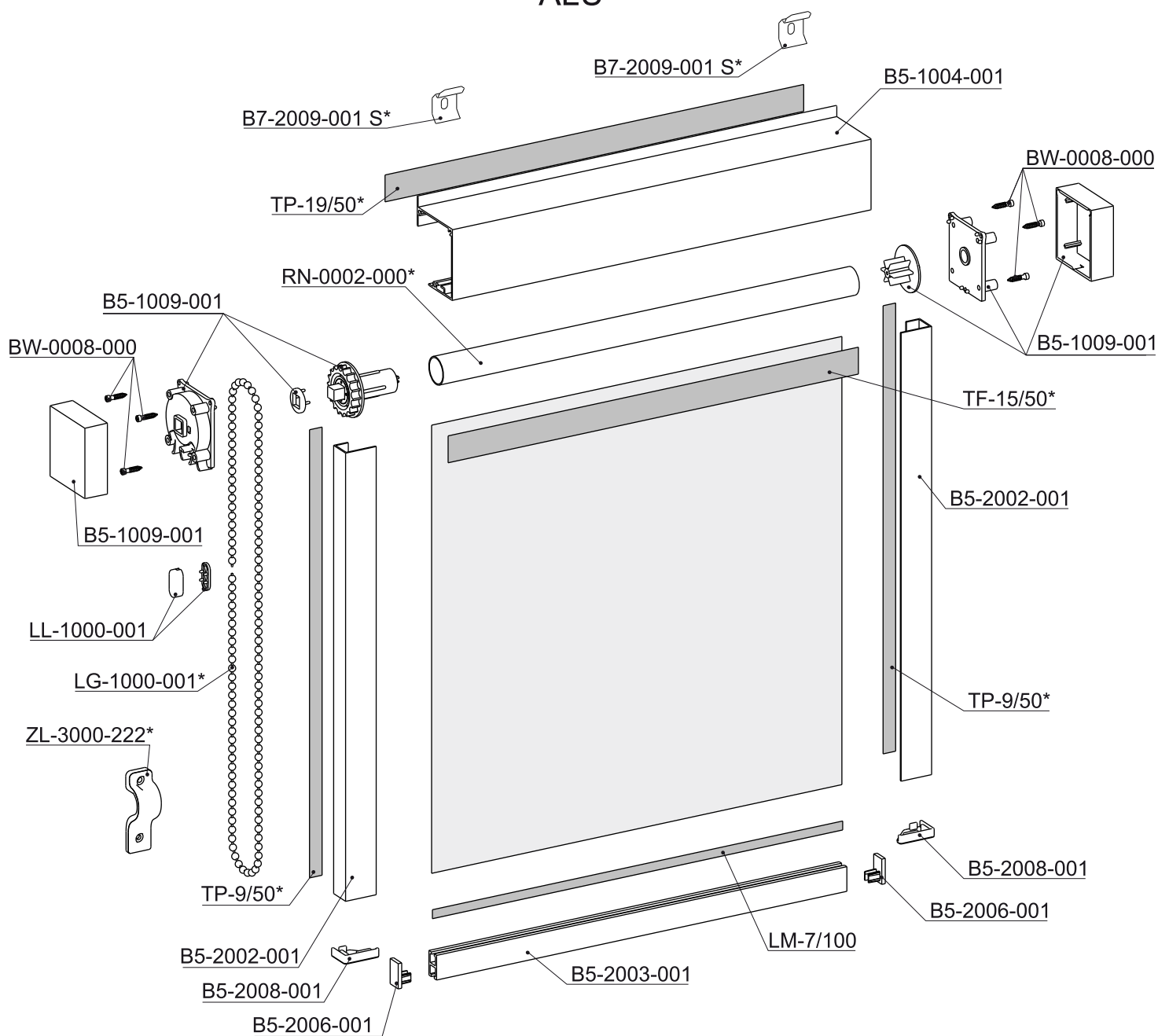

*	↻
RN-0002-000	RN-0006-000
LG-1000-001	LG-1000-001 P
ZL-3000-222	UL-1000-001
B7-2009-001 S	B7-2009-001
TF-15/50	DW-19/50, NTF-15/50, NDW-19/50
TP-9/50	NTP-9/40

# BAMAR 5 BIS / D&N

## ALU

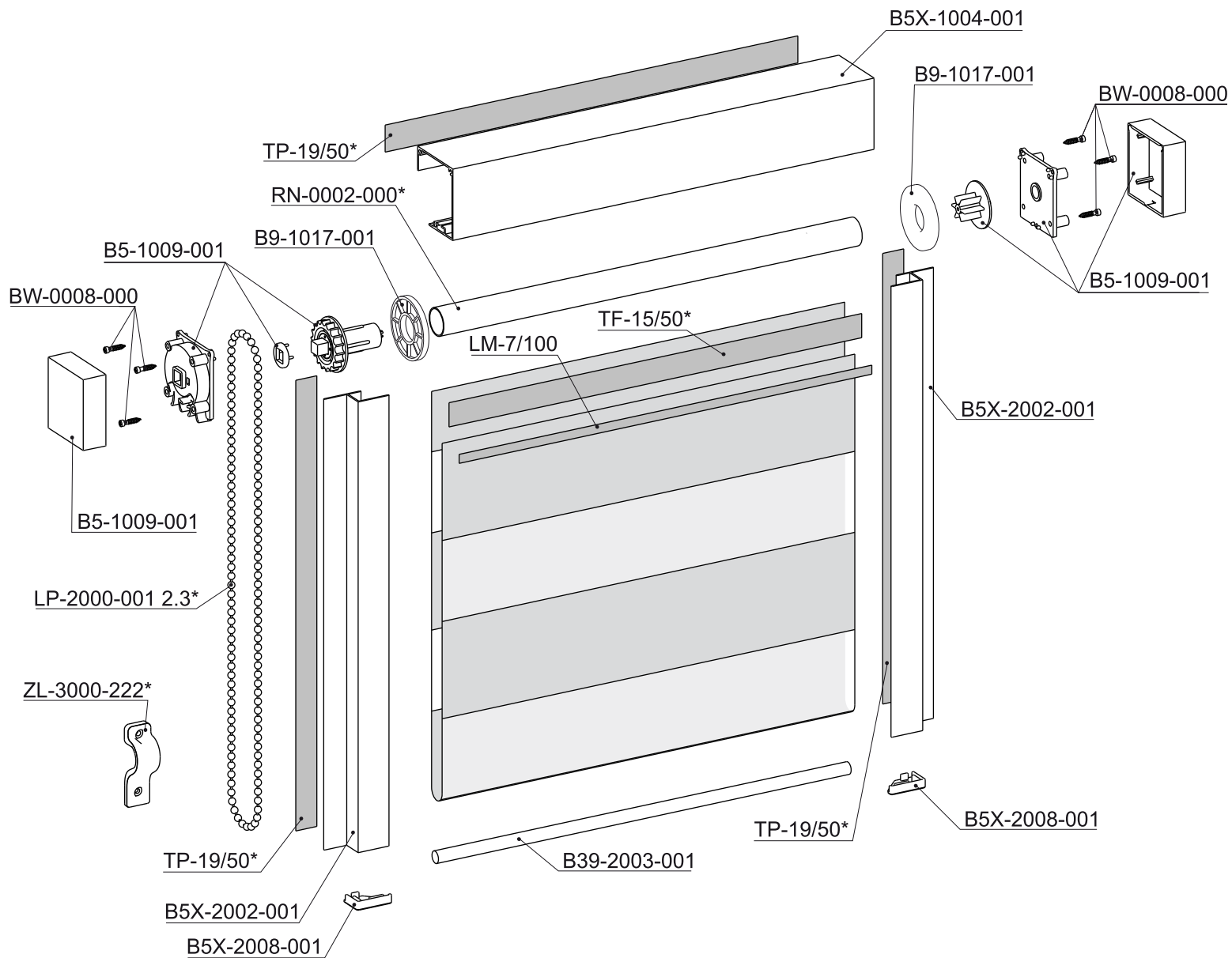

*	↻
RN-0002-000	RN-0006-000
LP-2000-001 2.3	LG-1000-501, LP-1000-001 2.4, LP-1000-001 3.6, LP-1024-001P, LP-1036-001P
ZL-3000-222	UL-1000-001
TF-15/50	DW-19/50, NTF-15/50, NDW-19/50
TP-19/50	NTP-19/40

# BAMAR 5 BIS



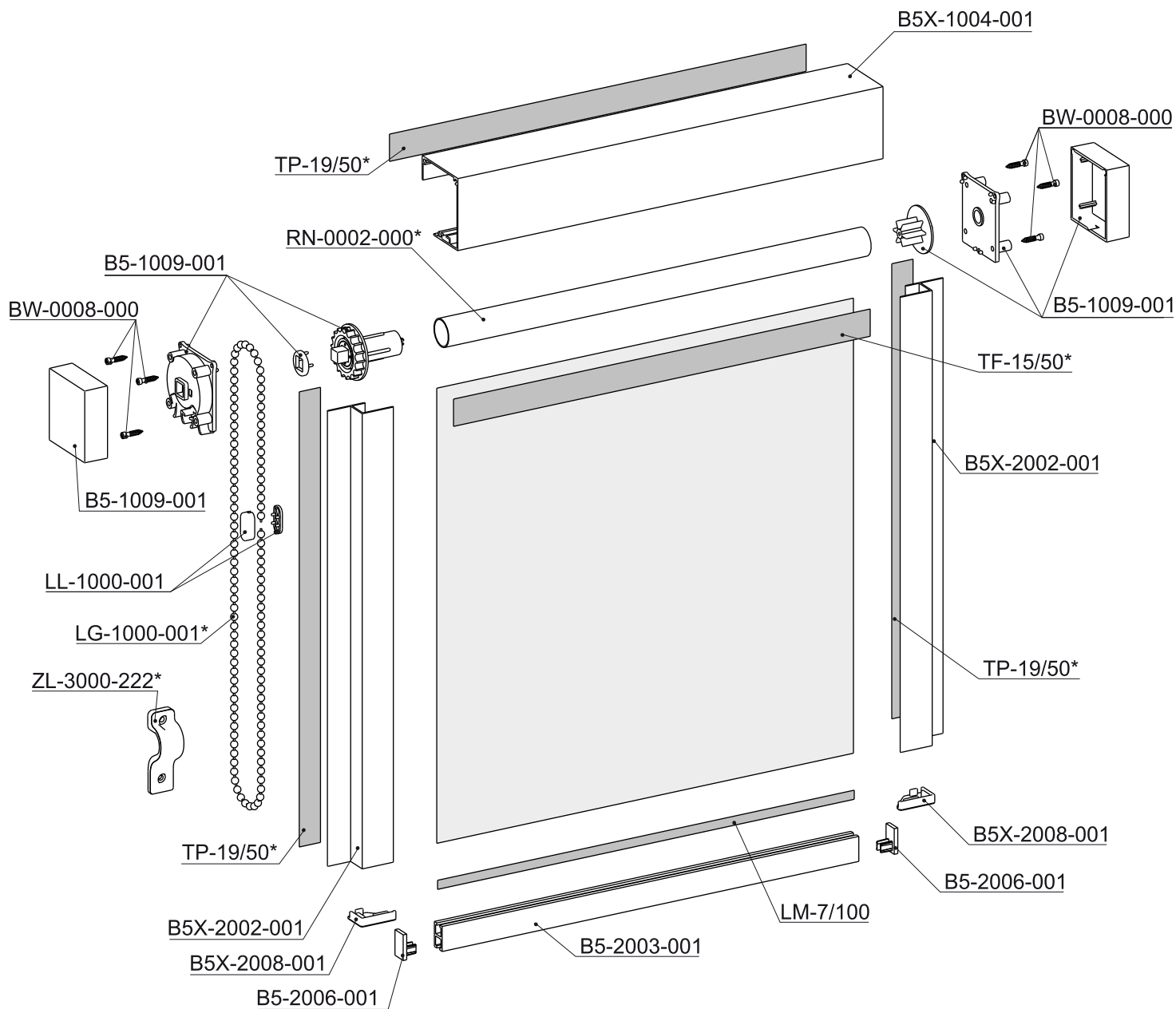



## ALU

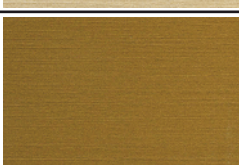

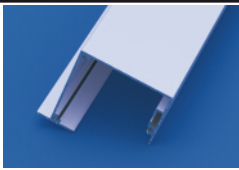
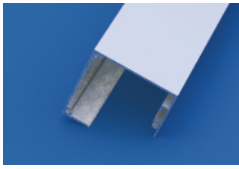
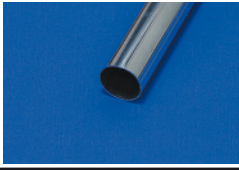
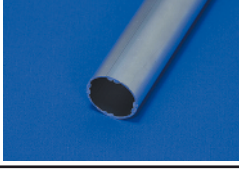

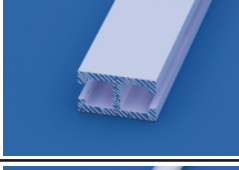

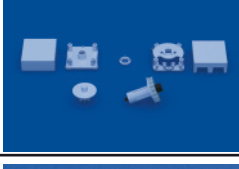



*	↻
RN-0002-000	RN-0006-000
LG-1000-001	LG-1000-001 P
ZL-3000-222	UL-1000-001
TF-15/50	DW-19/50, NTF-15/50, NDW-19/50
TP-19/50	NTP-19/40

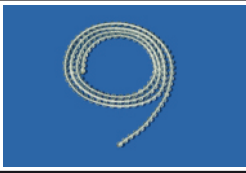



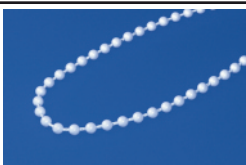

## BAMAR 5:

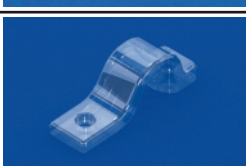
Kod Code Code Код	Kolor	Colour	Farbe	Цвет	
001	biały	white	weiss	белый	
003	antracyt	anthracite	anthrazit	антрацит	
111	srebrny	silver	silber	серебристый	
501	anoda matowa	matt anodic	matt anodische	анодированный матовый	
502	złota anoda	gold anodic	gold anodische	золотой анодированный	
503	satyna	satin	satin	сатина	
504	patyna	patin	patina	пatina	
505	czarna anoda	black anodic	schwarze anodische	чёрный анодированный	



Kod Code Code Код	Nazwa Name Bezeichnung Название	Kolor Colour Farbe Цвет	Pakowanie Packing Packen Упаковка	
<b>B5-1004-501</b>	Kaseta B5, biała ALU cassette B5 white ALU Kasette B5 Weiss Кассета B5 алюминиевая, белая	001, 003, 501, 502, 503, 504, 505	24/30 mb 24/30 lm 24/30 lm 24/30 м	
<b>B5X-1004-001</b>	Kaseta B5 BIS, biała ALU cassette B5 BIS white ALU Kasette B5 BIS Weiss Кассета B5 BIS алюминиевая, белая	001, 111	24 mb 24 lm 24 lm 24 м	
<b>RN-0002-000</b>	Rura aluminiowa 18,0 x 0,65, 6m Aluminium tube 18,0x0,65, 6m Aluminiumrohr 18,0 x 0,65, 6m Труба алюминиевая 18,0 x 0,65, 6м	000	60 mb 60 lm 60 lm 60 м	
<b>RN-0006-000</b>	Rura aluminiowa ożebrowana 19,0 x 1,1, 6m Aluminium tube strengthened 19,0x1,1, 6m Aluminiumrippenrohr 19,0 x 1,1, 6m Труба алюминиевая укреплённая 19,0 x 1,1, 6м	000	60 mb 60 lm 60 lm 60 м	
<b>B5-2002-001</b>	Prowadnica B5, biała ALU side guide B5 white ALU Seitenführung B5 weiss Направляющая B5 алюминиевая, белая	001, 003, 501, 502 503, 504, 505	60 mb 60 lm 60 lm 60 м	
<b>B5X-2002-001</b>	Prowadnica B5 BIS, biała ALU side guide B5 BIS white ALU Seitenführung B5 BIS weiss Направляющая B5 BIS алюминиевая, белая	001, 111	24 mb 24 lm 24 lm 24 м	
<b>B5-2003-001</b>	Belka obciążająca aluminiowa biała, 5.8m Aluminium bottom bar white, 5.8m Aluminium Unterleiste, 5.8m Планка нижняя алюминиевая белая, 5.8м	001, 003, 501, 502, 503, 504, 505	58 mb 58 lm 58 lm 58 м	
<b>B39-2003-001</b>	Pręt obciążający, biały Alu Tiltrod weight white Alu-Beschwerdestab- Weiss Прут-утяжелитель алюминиевый, белый	001, 002, 501, 502, 503, 504, 505	26,5/20 mb 26,5/20 lm 26,5/20 lm 26,5/20 м	
<b>B5-1009-001</b>	Napęd B5, biały Chain mechanism B5 white Antrieb B5, weiss Механизм управления B5, белый	001, 003, 501, 502, 503, 504, 505	25 kpl 25 set 25 kpl 25 компл	
<b>LG-1000-001</b>	Łańcuszek kulkowy Ø4,4mm, biały Ball chain Ø4,4mm, white Perlenkette Ø4,4 mm, weiss Цепочка шариковая Ø4,4мм, прозрачная	001, 010, 300, 414, 512, 513, 514	300 m 300 lm 300 lm 300м	



Kod Code Code Код	Nazwa Name Bezeichnung Название	Kolor Colour Farbe Цвет	Pakowanie Packing Packen Упаковка	
<b>LG-1000-001-P</b>	Łańcuszek kulkowy Ø4,45mm, przezroczysty Ball chain Ø4,45mm transparent Perlenkette Ø4,45 mm, transparent Цепочка шариковая Ø4,45mm, прозрачная	001, 111	250 mb 250 Lm 250 Lm 250 м	
<b>LP-1024-001 P</b>	Łańcuszek pętla 2,4m, transparentny Chain loop 2,4m transparent Endlosekette 2,4 lm Transparent Цепочка-петля, 2,4м, прозрачная	001	100 szt 100 pcs 100 st 100 шт	
<b>LP-1036-001 P</b>	Łańcuszek pętla 3,6m, transparentny Chain loop 3,6m transparent Endlosekette 3,6 lm Transparent Цепочка-петля, 3,6м, прозрачная	001	100 szt 100 pcs 100 st 100 шт	
<b>LG-1000-501</b>	Łańcuszek metalowy Metal ball chain Metall-Kette Цепочка металлическая	333, 502, 504, 505	100 szt 100 pcs 100 st 100 шт	
<b>LP-1000-001 2,4</b>	Łańcuszek pętla 2,4m Chain loop 2,4m Endlosekette 2,4 lm Цепочка-петля, 2,4м	001, 408, 411, 414	100 szt 100 pcs 100 st 100 шт	
<b>LP-1000-001 3,6</b>	Łańcuszek pętla 3,6m Chain loop 3,6m Endlosekette 3,6 lm Цепочка-петля, 3,6м	001, 408, 411, 414	100 szt 100 pcs 100 st 100 шт	
<b>LP-2000-001 2,3</b>	Łańcuszek pętla 2,3m Chain loop 2,3m Endlosekette 2,3 lm Цепочка-петля, 2,3м	001	100 szt 100 pcs 100 st 100 шт	
<b>LL-1000-001</b>	Łącznik łańcuszka, biały Connection clip, white Kugelhetteverbinder, weiss Соединитель цепочки, белый	001, 010, 222, 414	100 szt 100 pcs 100 st 100 шт	
<b>LL-1000-333</b>	Łącznik łańcuszka, metalowy Metal connection clip Kogelkettenverbinder, metall Соединитель цепочки металлический	333, 502, 504, 505	100 szt 100 pcs 100 st 100 шт	
<b>ZL-3000-222</b>	Uchwyt zabezpieczający łańcuszka, bezbarwny Safety handle for chain, transparent Sicherheitsgriff für die Kette, farblos Фиксатор цепочки, прозрачный	222	100 szt 100 pcs 100 st 100 шт	

Kod Code Code Код	Nazwa Name Bezeichnung Название	Kolor Colour Farbe Цвет	Pakowanie Packing Packen Упаковка	
UL-1000-001	Uchwyt łańcuszka, biały Chain handle, white Kettengriff, weiss Крепитель цепочки, белый	001, 011, 111	100 szt 100 pcs 100 st 100 шт	
B5-2006-001	Zaślepka belki B5, biały End cap for bottom bar B5, white Endkappe für Seitenführung B5, weiss Заглушка нижней планки B5, белая	001, 003, 501, 502, 503, 504, 505	100 szt 100 pcs 100 st 100 шт	
B5-2008-001	Zaślepka prowadnicy B5, biały End cap for side guide B5 white Endkappe für B35-Untereleiste, weiss Заглушка направляющей B5, белая	001, 003, 501, 502, 503, 504, 505	100 kpl 100 set 100 kpl 100 компл	
B5X-2008-001	Zaślepka prowadnicy B5 BIS, biały End cap for side guide B5 BIS white Endkappe für B5 BIS-Untereleiste, weiss Заглушка направляющей B5 BIS, белая	001, 111	100 kpl 100 set 100 kpl 100 компл	
BW-0008-000	Błachowkręt 2,9x13 Screw 2,9x13 Schraube 2,9x13 Шуруп 2,9x13	000, czarny, złoty	1000 szt 1000 pcs 1000 st 1000 шт	
B7-2009-001	Klip kasety B7 Biały Cassette clip B7 white Montage Clip B7 weiss Клип кассеты B7 белый	001	100 szt 100 pcs 100 st 100 шт	
B7-2009-001 S	Klip naścienny kasety B7, biały Wall clip for cassette B7 white Montage-Clip B-7 Weiss Клип настенный кассеты B7	001	500 szt 500 pcs 500 st 500 шт	
B9-1017-001	B9 krążek prowadzący, biały Disc B9, white B9 Führungsscheibe, weiss Диск B9, белый	001	100 szt 100 pcs 100 st 100 шт	

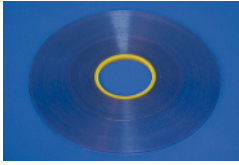
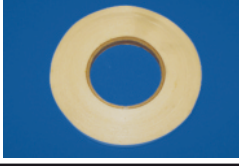
Kod Code Code Код	Nazwa Name Bezeichnung Название	Szerokość Width Breite Ширина	Pakowanie Packing Packen Упаковка	
DW-19/50	Taśma dwustronna wzmocniona Strengthened double-sided tape Doppelseitiges verstärktes Klebeband Лента двухсторонняя укреплённая	9, 12, 15, 19, 25, 38	1 szt 1 pcs 1st 1 шт	

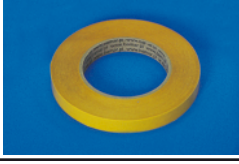
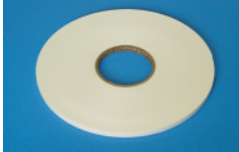
Kod Code Code Код	Nazwa Name Bezeichnung Название	Szerokość Width Breite Ширина	Pakowanie Packing Packen Упаковка	
<b>TP-9/50</b>	Taśma piankowa Foam tape Schaumklebeband Лента пенковая	8, 9, 12, 15, 19	1 szt 1 pcs 1st 1 шт	
<b>LM-7/100</b>	Listwa mocująca z klejem Fastening belt with glue Befestigungsleiste mit Kleber Полоска для крепления с клеем	4, 6, 7, 8, 9, 17	1 szt 1 pcs 1st 1 шт	
<b>TF-15/50</b>	Taśma dwustronna na flizelinie, Flizeline double-sides tape Doppelseitiges Klebeband, Лента двухсторонняя на флизелине	9, 12, 15, 19	1 szt 1 pcs 1st 1 шт	
<b>NDW-19/50</b>	Taśma dwustronna wzmocniona Strengthened double-sided tape Doppelseitiges verstärktes Klebeband Лента двухсторонняя укрепленная	15, 19	1 szt 1 pcs 1st 1 шт	
<b>NTF-15/50</b>	Taśma dwustronna na flizelinie, Flizeline double-sides tape Doppelseitiges Klebeband, Лента двухсторонняя на флизелине	12, 15, 19	1 szt 1 pcs 1st 1 шт	
<b>NTP-15/40</b>	Taśma piankowa Foam tape Schaumklebeband Лента пенковая	9, 15, 19	1 szt 1 pcs 1st 1 шт	

**SIEDZIBA / OFFICE**

46-024 Jełowa POLAND  
ul. Dworcowa 20  
tel.: +48 77 421 13 71  
tel.: +48 77 427 01 10  
fax: +48 77 421 14 28

**MARKETING / DZIAŁ HANDLOWY**

tel.: +48 77 427 01 10  
fax: +48 77 421 14 28  
e-mail: marketing@bamar.pl  
e-mail: handlowy@bamar.pl

**MAGAZYN / WAREHOUSE**

47-100 Strzelce Opolskie POLAND  
ul. 1-go Maja 50  
tel./fax +48 77 404 95 15  
e-mail: jan-strz@bamar.pl  
e-mail: magazyn@bamar.pl

**EXPORT**

tel.: +48 77 427 01 00  
fax: +48 77 427 01 01  
e-mail: export@bamar.pl